

RESTEK LC Columns and Accessories



Pure Chromatography

www.restek.com/lc

This is Restek LC

Restek has been perfecting the art and science of liquid chromatography (LC) for more than a quarter-century. Over that time, the burdens placed on LC systems and analysts have changed dramatically, especially with the adoption and explosive growth of LC-MS/MS in modern analytical laboratories. With each passing year, there is a higher demand for chromatography consumables to be reliable, to generate reproducible data, and to retain and resolve greater numbers of more difficult compounds. The employee-owners of Restek pride ourselves on being experts in chromatography, and we use our experience to help analysts like you solve the challenges you face on a daily basis in this rapidly shifting landscape.

Our state-of-the-art, high-quality lines of LC columns—Raptor, Force, and Roc—with industry-leading stationary phases have been designed and built to address the needs of not only today's markets, but also tomorrow's. Extensive testing, competitor benchmarking, and strict QC systems ensure that all of our columns will consistently produce the results you must have time and time again, now and in the future. We also offer instrument replacement parts that meet or even exceed the original manufacturer's performance. And, as it has been since the beginning, Restek is proud to be an independent company, and we will support every LC you have, regardless of who made it.

Whether you are in a high-throughput analytical laboratory with crushing deadlines and a rising backlog or in a research and development organization with a tight budget and towering goals, Restek is the partner you need to make your LC work flow.

We invite you to look through this highlighted selection of Restek LC columns and accessories. For more LC products, as well as GC, sample preparation, and more, be sure to visit www.restek.com

The Employee-Owners of Restek

RESTEK



Table of Contents

This is Restek LC	2
LC Columns Overview	4
LC Phases Overview	5
LC Guards Overview	5
Raptor SPP LC Columns	6
Overview	7
Biphenyl	11
ARC-18	16
FluoroPhenyl	21
C18	27
HILIC-Si	31
EtG/EtS	38
Force Performance LC Columns	42
Overview	43
Biphenyl	47
C18	48
FluoroPhenyl	49
Guard Columns	50
Roc LC Columns	52
Overview	53
Phases	56
Guard Columns	56
Routine Maintenance Supplies	58
Agilent LCs	58
Shimadzu LCs	62
Waters ACQUITY LCs	65
Waters Alliance LCs	68
Mobile Phase Management	71
EXP Connectors	75
PEEK Tubing & Connectors	79
Well Plates & Mats	81
Trident LC Column Protection	82
Tables & Reference	83
LC Columns Physical Characteristics Chart	84

Fast, Personalized, and Thorough Answers

Restek's highly diverse Technical Service team collectively represents hundreds of years of hands-on chromatography experience and specializes in providing information about Restek products, applications, instrument troubleshooting, method development, and more. For answers to your most challenging technical questions, just send us an email!

Customers Inside the U.S.
support@restek.com

Customers Outside the U.S.
 Contact your local Restek representative or email
support@restek.com



Rugged, Reproducible Columns from Restek Make Your LC Work Flow



Overview: SPP, or “core-shell,” columns designed specifically to accelerate your analyses while maintaining reproducibility and ruggedness.

Ideal for: High-throughput LC-MS/MS.

Instruments supported:

- Agilent 1260 & 1200 RRLLC
- Waters ACQUITY Arc
- Shimadzu Nexera XR (UFLCXR) & i-Series (LC-2040)

See page: 6.

Learn more: www.restek.com/raptor



Overview: Premium, long-lasting, and reproducible columns for HPLC and UHPLC; fully scalable from 1.8 μm to 3 μm to 5 μm .

Ideal for: Scaling methods between HPLC and UHPLC.

Instruments supported:

- Agilent 1290
- Waters ACQUITY H&I Class
- Shimadzu Nexera X2

See page: 42.

Learn more: www.restek.com/force



Overview: Solid and dependable columns made for exceptional value and traditional HPLC use, particularly with USP methods.

Ideal for: Compendia or routine, low-pressure use.

Instruments supported:

- Agilent 1100 & 1200
- Waters Alliance
- Shimadzu Prominence & i-Series (LC-2030)

See page: 52.

Learn more: www.restek.com/roc

Other LC Columns Available from Restek

Ultra LC Columns: Specialty phases and prep columns.

Viva LC Columns: Large porosity columns for biomolecule analysis.

Allure LC Columns: High-surface area silica and specialty phases.

Pinnacle DB LC Columns: Standard-phase UHPLC columns.

Pinnacle II PAH Columns: Specialty phase for analysis of polycyclic aromatic hydrocarbons (PAHs).

Find them all at www.restek.com/LC

LC Stationary Phases with the Selectivity for Your Challenging and Complex Separations

Whether your application calls for a straight-up C18 or for something with a little more “punch” like the time-tested and industry-first Restek Biphenyl, we have the phases you need. Huge analyte panels, isobars, isomers, structurally similar compounds, matrix interferences, and more—with Restek phases, you’ll make quick work of any application. Here’s a look at some of our most popular phases. Flip through this book for more.

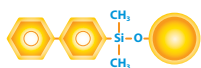

Time-Tested Restek Biphenyl Phase:

The established choice for bioanalytical testing since 2005. See pages: 11, 47.



Reliably Versatile Restek FluoroPhenyl Phase:

Get the power of HILIC and RP modes in one LC column. See pages: 21, 49.



Acid-Resistant Restek ARC-18 Phase:

Ahead of the curve for large, multiclass lists by mass spec. See page: 16.

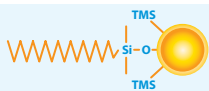

General-Purpose Restek C18 Phase:

Traditional end-capped C18 ideal for general-purpose use. See pages: 27, 48, 56.



Rugged, MS-Friendly Restek HILIC-Si Phase:

Simplify the switch to HILIC on both HPLC and UHPLC systems. See page: 31.



Matrix-Resolving Restek EtG/EtS Phase:

Separate analytes from interferences in a fast, 4-minute dilute-and-shoot method. See page: 38.

Protect the Most Expensive Consumable in Your Chromatographic Assay with Restek LC Guards

EXP Direct Connect Holder & Guard Column Cartridges:

For 3 and 5 μm Force & 1.8 μm, 2.7 and 5 μm Raptor LC Columns

See pages: 14, 20, 26, 30, 37, 50.



UltraShield UHPLC PreColumn Filters:

For 1.8 μm Force & Raptor LC Columns

See pages: 14, 20, 26, 30, 40, 50.



Roc LC Guard Column Holder & Cartridges:

For Roc LC Columns

See page: 56.



Trident LC Column Protection System:

For Ultra, Viva, and Pinnacle DB LC Columns

See page: 82.



SPP or FPP?

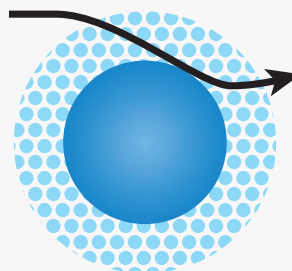

Superficially porous particles (SPP) are becoming increasingly popular for providing faster, more efficient analyses without UHPLC pressures. And when speed is your goal, Restek recommends the Raptor line of LC columns (www.restek.com/raptor).

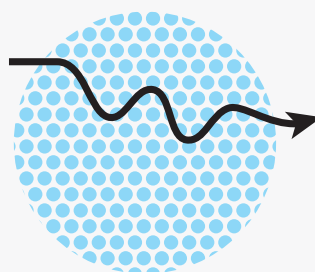

However, retention is often just as important to sharpen peaks and increase sensitivity for mass spec, and when that is the case, fully porous particle (FPP) Force LC columns (www.restek.com/force) are ready to be put to work.

Either way, Restek has a high-performing, reliable LC column for you.

Force C18 1.8 μm

Sharper peaks

Peaks	SIR (m/z)
1. Daidzin	417.2
2. Genistin	433.2
3. Daidzein	255.1
4. Genistein	271.1

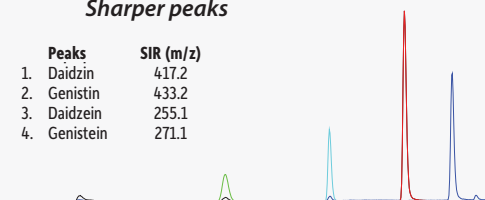

Raptor C18 2.7 μm

Less retention

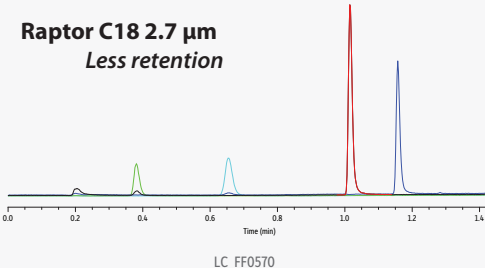

Columns Force C18 1.8 μm, 50 x 2.1 mm (cat# 9634252), max pressure = 500 bar and Raptor C18 2.7 μm, 50 x 2.1 mm (cat# 9304A52), max pressure = 225 bar, Temp.: 50 °C; Sample Custom mix, Diluent: Water, Conc.: 500 ng/mL, Inj. Vol.: 2 μL; Mobile Phase A: Water + 0.1% formic acid, B: Acetonitrile + 0.1% formic acid; Gradient (%B): 0.00 min (15%), 1.50 min (95%), 1.51 min (15%), 3.00 min (15%); Flow: 0.6 mL/min; Detector: MS; Interface: ESI+; Instrument: UHPLC.

Raptor

LC Columns

Selectivity Accelerated

The speed of SPP with the resolution of USLC technology for fast, efficient method development that delivers:

- Drastically faster analysis times.
- Substantially improved resolution.
- Increased sample throughput with existing instrumentation.
- Dependable reproducibility.

www.restek.com/raptor



Raptor SPP LC Columns—The Dawn of an Era

The efficiency of superficially porous particles (commonly referred to as SPP or “core-shell” particles) has been proven to provide fast separations with lower backpressures. This benefit helps customers achieve faster separations with their existing HPLC instruments. Coupled with small-particle technology, SPP particles also provide an efficiency boost to those running UHPLC when compared to fully porous particles. SPP particles feature a solid, impermeable core enveloped by a thin, porous layer of silica that decreases the diffusion path and reduces peak dispersion. As a result, they offer significantly higher efficiency than traditional fully porous particles of similar dimensions. Core-shell particles changed LC, but they were only the beginning....

A New Species Has Evolved

Restek is proud to announce that SPP core-shell technology has evolved with the introduction of Raptor LC columns. Although column efficiency, which is boosted with superficially porous particles, considerably accelerates analysis time, it has little effect on resolution (i.e., peak separation). Selectivity, on the other hand, has a substantial impact on resolution, but shows minimal improvement in analysis times. Raptor LC columns bond rugged 1.8, 2.7, and 5 μm superficially porous particles with Restek’s unique Ultra Selective Liquid Chromatography (USLC) phases to offer chromatographers the best of both worlds.

By being the first to combine the speed of SPP with the resolution of highly selective USLC technology, Raptor LC columns provide analysts with the most powerful tools available for fast and efficient method development. And, because they are from Restek, Raptor LC columns are backed by the manufacturing and quality systems you’ve come to trust along with the best Plus 1 service in the industry. Choose them for all of your valued assays to experience *Selectivity Accelerated*.

Figure 1: Only Raptor LC columns offer the higher efficiency of a superficially porous particle *plus* the improved resolution of USLC phases.

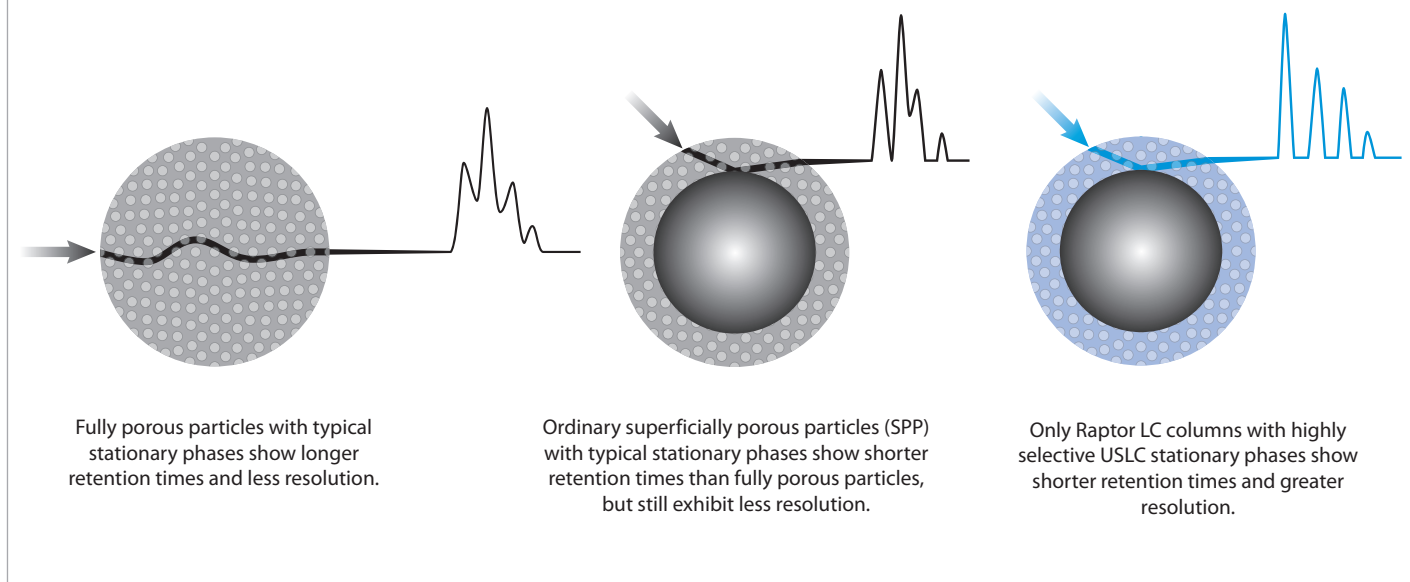



Experience *Selectivity Accelerated*. Put Raptor LC columns and guards to the test today on your most challenging workflows.

Evolutionary Chromatography

It is only possible to fully utilize the efficiency of superficially porous particle technology when it is united with the power of USLC selectivity. With Raptor columns, you can speed up method development and enhance sample throughput. Using 2.7 and 5 μm columns, traditional HPLC instruments gain significant efficiency and selectivity improvements without the need to upgrade, and Raptor 1.8 μm LC columns can evolve UHPLC workflows by providing a one-two efficiency punch: superficially porous shells on small-core particles.

- Run faster and avoid lengthy gradient adjustments.
- Separate isobaric and hard-to-resolve compounds with ease.
- Avoid eluting compounds near the void volume and limit ion suppression.
- Skip the complex mobile phases and multiple method modifications.

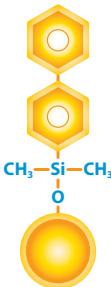
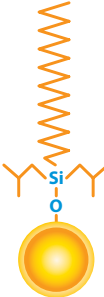
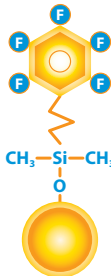
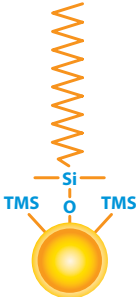
Raptor Family of LC Phases

	Biphenyl	ARC-18	FluoroPhenyl	C18	HILIC-Si	EtG/EtS
						
USP Phase Code	L11	L1	L43	L1	L3	n/a
Stationary Phase Category	Phenyl	C18, octadecylsilane	Pentafluorophenyl propyl	C18, octadecylsilane	bare silica	Proprietary
Ligand Type	Biphenyl	Sterically protected C18	Fluorophenyl	End-capped C18	none	Proprietary
Particle Size	1.8 μm , 2.7 μm , or 5 μm superficially porous silica (SPP or "core-shell")	1.8 μm , 2.7 μm , or 5 μm superficially porous silica (SPP or "core-shell")	1.8 μm , 2.7 μm , or 5 μm superficially porous silica (SPP or "core-shell")	1.8 μm , 2.7 μm , or 5 μm superficially porous silica (SPP or "core-shell")	2.7 μm superficially porous silica (SPP or "core-shell")	2.7 μm superficially porous silica (SPP or "core-shell")
Pore Size	90 Å	90 Å	90 Å	90 Å	90 Å	90 Å
Surface Area	125 m ² /g (1.8 μm), 130 m ² /g (2.7 μm), or 100 m ² /g (5 μm)	125 m ² /g (1.8 μm), 130 m ² /g (2.7 μm), or 100 m ² /g (5 μm)	125 m ² /g (1.8 μm), 130 m ² /g (2.7 μm), or 100 m ² /g (5 μm)	125 m ² /g (1.8 μm), 130 m ² /g (2.7 μm), or 100 m ² /g (5 μm)	130 m ² /g (2.7 μm)	130 m ² /g (2.7 μm)
Carbon Load	7% (1.8 μm), 7% (2.7 μm), 5% (5 μm)	7% (1.8 μm), 7% (2.7 μm), 5% (5 μm)	4% (1.8 μm), 4% (2.7 μm), 3% (5 μm)	9% (1.8 μm), 7% (2.7 μm), 5% (5 μm)	n/a	Proprietary
End-Cap	yes	no	no	yes	no	Proprietary
pH Range	1.5–8.0	1.0–8.0	2.0–8.0	2.0–8.0	2.0–8.0	2.0–8.0
Maximum Temperature	80 °C	80 °C	80 °C	80 °C	80 °C	80 °C
Maximum Pressure	1,034 bar/15,000 psi* (1.8 μm), 600 bar/8,700 psi (2.7 μm); 400 bar/5,800 psi (5 μm)	1,034 bar/15,000 psi* (1.8 μm), 600 bar/8,700 psi (2.7 μm); 400 bar/5,800 psi (5 μm)	1,034 bar/15,000 psi* (1.8 μm), 600 bar/8,700 psi (2.7 μm); 400 bar/5,800 psi (5 μm)	1,034 bar/15,000 psi* (1.8 μm), 600 bar/8,700 psi (2.7 μm); 400 bar/5,800 psi (5 μm)	600 bar/8,700 psi (2.7 μm)	600 bar/8,700 psi (2.7 μm)

* For maximum lifetime, recommended maximum pressure for 1.8 μm particles is 830 bar/12,000 psi.

Dissecting Raptor LC Columns

A closer look at a new species

Adaptive Traits: Raptor LC Column

Restek's dedicated R&D group studied every aspect of superficially porous particles (commonly referred to as SPP or "core-shell" particles) to develop the bonding chemistries that are best suited to both the SPP construction and our highly selective USLC phases. But we didn't stop there. In addition to implementing a new, proprietary column-packing technique, we upgraded our LC column hardware. By looking at not only the particles, but also the packing and hardware, we have made sure that you will get repeatable, rugged performance from each and every Raptor LC column.

Specially Selected Frits

Precision control over particle size allows the largest possible frit size, which prevents clogging, increases column lifetimes, and helps maintain optimal pressures.

Rugged Label

Clearly identifies both flow direction and column; resists solvents and tearing to last as long as your column does.



Proprietary Column-Packing Technique

Provides greater pressure stability and achieves higher linear velocities without sacrificing efficiency or lifetime; columns hold up under the rigors of UHPLC injection cycles.



Raptor SPP Particles

A Range of Robust Particles
Accelerate traditional HPLC with 2.7 and 5 μm particles; boost UHPLC with 1.8 μm .

Narrow Silica Distribution
Ensures high efficiency and consistent flows.

Updated Bonding and QC
Guarantee retention time stability, run to run and column to column.

Natural Protection

Raptor EXP Guard Column— for All Raptor Columns

Regardless of its performance, lifespan, or frit size, the LC column is the most expensive consumable used for your chromatographic assay. To help protect your investment and further extend the life of our already-rugged Raptor LC columns, we have mated our new superficially porous particles with patented guard column hardware developed by Optimize Technologies. Great with any Raptor column to get ultimate protection from particulates and matrix contamination, especially when using dilute-and-shoot or other minimal sample preparation techniques.

Patented Titanium Hybrid Ferrules

Can be installed repeatedly without compromising high-pressure seal.

Free-Turn Architecture

Allows you to change cartridges without breaking inlet/outlet fluid connections—and without tools.

Auto-Adjusting Connection

Provides ZDV (zero dead volume) connection to any 10-32 female port.



Flexible Design

Replace nut with longer or even tool-free options (below) to best suit your needs.



Unidirectional Raptor Cartridge

In-Tandem Development

Made to pair perfectly with Raptor LC columns.

Superior Packing Technique

Withstands 1,034 bar (UHPLC)/600 bar (2.7 μm)/400 bar (5 μm) operating pressures.

Restek Quality

Backed by the manufacturing and QC systems you trust.

See page 76 for EXP fittings.

See pages 14, 20, 26, 30, 37, and 50 for Raptor guard column cartridges.

Hybrid Ferrule U.S. Patent No. 8201854, EXP Holders U.S. Patent No. 8696902, EXP2 Wrench U.S. Patent No. D766055. Other U.S. and Foreign Patents Pending. The EXP, Free-Turn, and the Opti- prefix are registered trademarks of Optimize Technologies, Inc.



UltraShield UHPLC PreColumn Filter — for 1.8 μm Raptor Columns

Pair 1.8 μm Raptor columns with an UltraShield filter instead of a guard cartridge to minimize extra column volume and maximize UHPLC sample throughput when using SPE, SLE, or other extensive sample preparations. They offer economical protection against microparticles with a negligible effect on column performance, and they are leak tight to 15,000 psi (1,034 bar). Better yet, an UltraShield filter won't contribute to system backpressure band broadening.

Description	Filter		
	Porosity	qty.	cat.#
UltraShield UHPLC PreColumn Filter	0.2 μm frit	ea.	25809
		5-pk.	25810
		10-pk.	25811

The Raptor Biphenyl Column—Fast, Rugged Raptor Columns with Time-Tested Selectivity

With Raptor LC columns, Restek chemists became the first to combine the speed of 2.7 and 5 μm superficially porous particles (also known as SPP or “core-shell” particles) with the resolution of highly selective USLC technology, improving separations and speeding up analysis times with standard HPLC instruments. Raptor then evolved to bring that same improved speed, efficiency, and selectivity to UHPLC analyses by offering 1.8 μm particle columns. Learn more about Raptor LC columns at www.restek.com/raptor

Our top priority when developing our SPP line was to create a version of our innovative Biphenyl. The industry-leading Biphenyl is Restek's most popular LC stationary phase because it is particularly adept at separating compounds that are hard to resolve or that elute early on C18 and other phenyl chemistries. As a result, the rugged Raptor Biphenyl column is extremely useful for fast separations in bioanalytical testing applications such as drug and metabolite analyses, especially those that require a mass spectrometer (MS). Increasing retention of early-eluting compounds can limit ionization suppression, and the heightened selectivity helps eliminate the need for complex mobile phases that are not well suited for MS detection.

In 2005, Restek was the first to bring you the benefits of the Biphenyl ligand, and we have the experience to maximize the SPP performance of this premier phenyl chemistry for today's challenging workflows.

Column Description:



Stationary Phase Category:

Phenyl (L11)

Ligand Type:

Biphenyl

Particle:

1.8 μm , 2.7 μm , or 5 μm superficially porous silica (SPP or “core-shell”)

Pore Size:

90 Å

Surface Area:

125 m^2/g (1.8 μm),
130 m^2/g (2.7 μm),
or 100 m^2/g (5 μm)

Recommended Usage:

pH Range: 1.5–8.0

Maximum Temperature: 80 °C

Maximum Pressure: 1,034 bar/15,000 psi* (1.8 μm),
600 bar/8,700 psi (2.7 μm); 400 bar/5,800 psi (5 μm)

* For maximum lifetime, recommended maximum pressure for 1.8 μm particles is 830 bar/12,000 psi.

Properties:

- Increased retention for dipolar, unsaturated, or conjugated solutes.
- Enhanced selectivity when used with methanolic mobile phase.
- Ideal for increasing sensitivity and selectivity in LC-MS analyses.

Switch to a Biphenyl when:

- You observe limited selectivity on a C18.
- You need to increase retention of hydrophilic aromatics.

Column Interaction Profile:

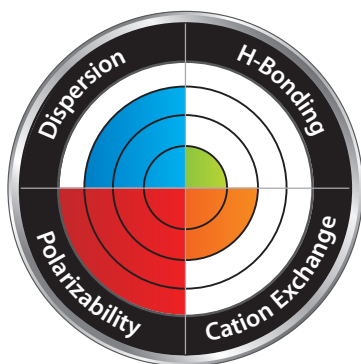

Defining Solute Interactions:

- Polarizability
- Dispersion

Complementary Solute Interaction:

- Cation exchange

Solute Retention Profile:

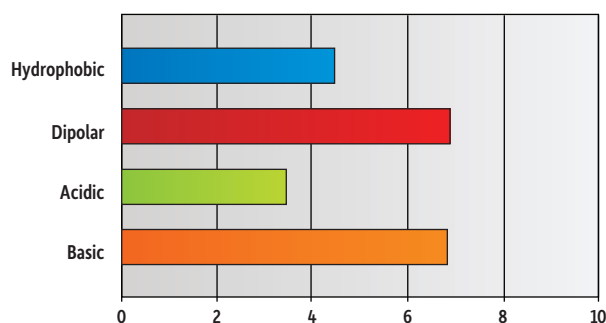

Target Analyte Structures:

- Aromatic
- Dipolar

Target Analyte Functionalities:

- Hydrophilic aromatics
- Strong dipoles
- Lewis acids
- Dipolar, unsaturated, or conjugated compounds
- Fused-ring compounds with electron withdrawing groups

The New Standard for Performance and Durability for SPP Core-Shell Columns

Pressure Stability:

One of the greatest advantages of an SPP column is the ability to achieve fast, efficient separations by operating at higher linear velocities than are possible with a conventional fully porous particle column. However, these higher velocities can also result in higher backpressures. Raptor columns were designed to handle the increased pressures needed to achieve *Selectivity Accelerated*, and handle it far better than other SPP columns on the market (Figure 2).

Reproducibility:

To help keep your productivity high and your lab budget low, we know that Raptor Biphenyl columns must produce exceptional selectivity and fast analysis times not just once, but every time. Ruggedness and repeatability are essential, which is why, from the silica and the bonding technique to the packing process and upgraded hardware, every decision that went into creating this column was made to ensure superlative reproducibility, from injection to injection (Figure 3) and from lot to lot (Figure 4). We also adopted new quality control (QC) specifications to guarantee the retention time stability you need for worry-free MRM analyses.

Figure 3: Even after hundreds of injections, a Raptor Biphenyl column will provide consistent, reliable data.

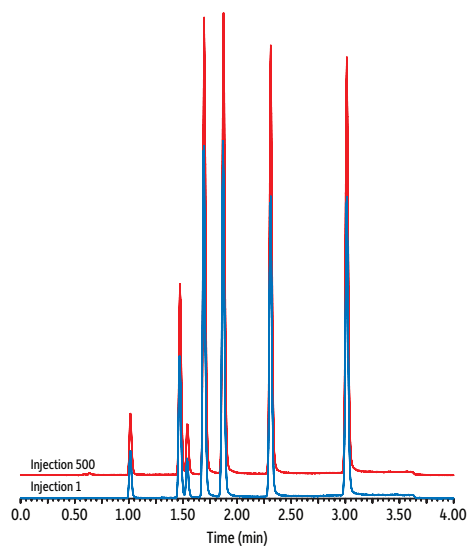

- Peaks**
1. Cortisol
 2. 11-Deoxycortisol
 3. Estradiol
 4. Boldenone
 5. Testosterone
 6. Androstenedione
 7. Progesterone

Column: Raptor Biphenyl (cat.# 9309A1E); Dimensions: 100 mm x 3.0 mm ID; Particle Size: 2.7 µm; Pore Size: 90 Å; Temp.: 30 °C; **Sample:** Diluent: initial mobile phase; Conc.: 50 ng/mL; Inj. Vol.: 5 µL **Mobile Phase:** A: 0.1% formic acid in water, B: 0.1% formic acid in acetonitrile; **Gradient (%B):** 0.00 min (40%), 3.00 min (80%), 3.01 min (40%), 5.00 min (40%); **Flow:** 0.700 mL/min; **Detector:** Waters Xevo TQ-S; Ion Mode: ESI+; **Instrument:** Waters.

Figure 2: At high pressures, competitor phenyl-hexyl columns experience a quick and sharp drop-off in efficiency, but Raptor Biphenyl columns are unaffected to at least 3,000 injections.

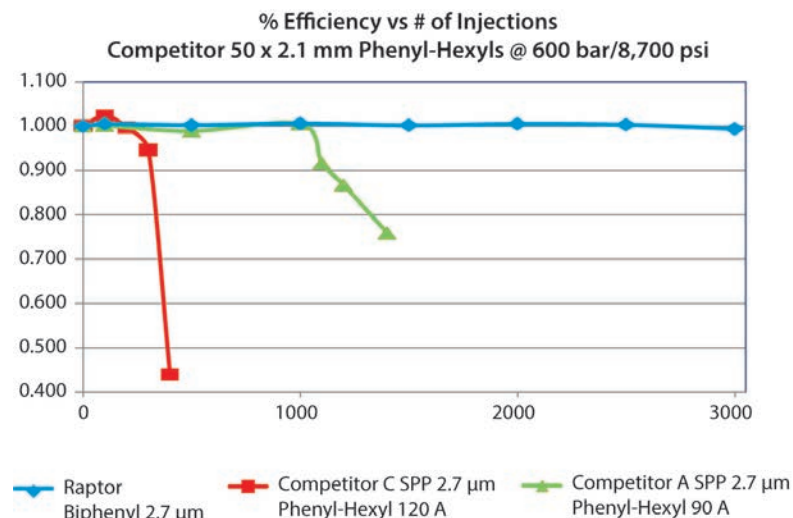
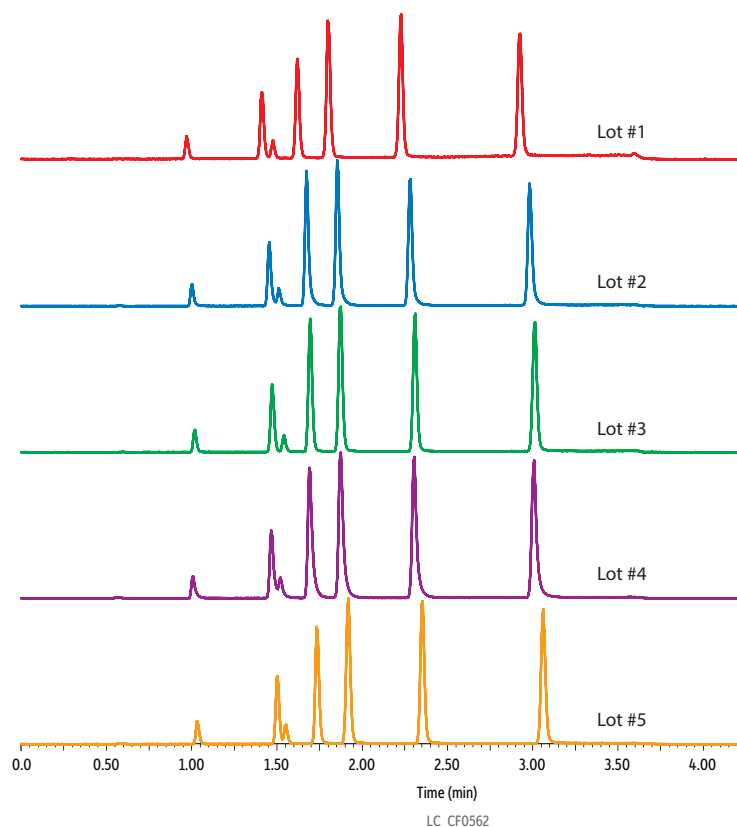

Figure 4: From one lot to the next, every Raptor Biphenyl column you purchase will perform the same.



See Figure 3 for compound list and conditions.

Clinically Proven to Optimize Your Bioanalytical Workflows

For over a decade, the Restek Biphenyl has been the column of choice for clinical testing because of its ability to provide highly retentive, selective, and rugged reversed-phase separations of drugs and metabolites. By bringing the speed of SPP to the Biphenyl family, the Raptor Biphenyl provides clinical labs with an even faster option for a wide variety of clinical assays.

Rugged Pain Panels from Urine in Under 3.5 Minutes

Pain panels can be difficult to optimize and reproduce due to the limited selectivity of C18 and phenyl-hexyl phases, but not on the Raptor Biphenyl. Complete your pain panel analysis with a 5-minute cycle time and complete isobaric resolution using Raptor Biphenyl columns (Figure 5). Popular competitor columns offer tailing peaks, longer run times, and coelutions; the Raptor Biphenyl exhibits the selectivity and performance needed for this critical analysis.

Figure 5: Raptor Biphenyl columns offer pain panel analyses with complete isobaric resolution in under 5 minutes!

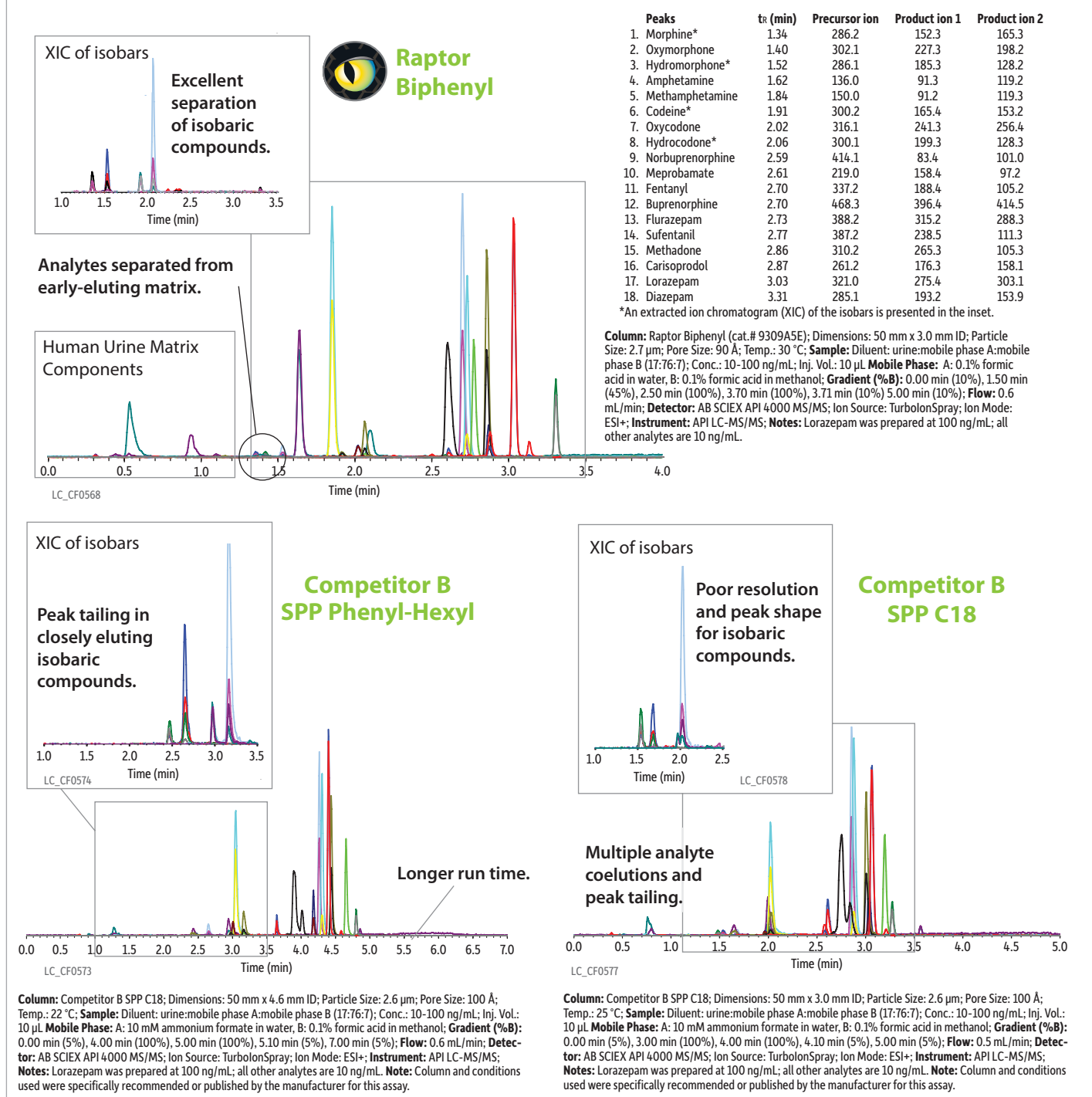

Accelerated Performance and Time-Tested Biphenyl Selectivity for Clinical Diagnostic, Pain, Pharma, and Environmental Labs

Raptor Biphenyl LC Columns



Length	2.1 mm cat.#	3.0 mm cat.#	4.6 mm cat.#
1.8 µm Columns			
30 mm	9309232	—	—
50 mm	9309252	930925E	—
100 mm	9309212	930921E	—
150 mm	9309262	—	—
2.7 µm Columns			
30 mm	9309A32	9309A3E	9309A35
50 mm	9309A52	9309A5E	9309A55
100 mm	9309A12	9309A1E	9309A15
150 mm	9309A62	9309A6E	9309A65
5 µm Columns			
30 mm	—	930953E	—
50 mm	9309552	930955E	9309555
100 mm	9309512	930951E	9309515
150 mm	9309562	930956E	9309565
250 mm	—	—	9309575

EXP Reusable Fittings for HPLC & UHPLC for 10-32 fittings and 1/16" tubing

Effortlessly achieve 8,700+ psi HPLC seals by hand! (Wrench tighten to 20,000+ psi.) Hybrid titanium/PEEK seal can be installed repeatedly without compromising your seal.



Description	qty.	cat.#
EXP Hand-Tight Fitting (Nut w/Ferrule)	ea.	25937
EXP Hand-Tight Fitting (Nut w/Ferrule)	10-pk.	25938
EXP Hand-Tight Nut (w/o Ferrule)	ea.	25939

Hybrid Ferrule U.S. Patent No. 8201854, Optimize Technologies. EXP Holders U.S. Patent No. 8696902, Optimize Technologies. EXP2 wrench U.S. Patent No. D766055, Optimize Technologies. Other U.S. and Foreign Patents Pending. The Opti- prefix is a registered trademark of Optimize Technologies, Inc.

Experience *Selectivity Accelerated*.
Order the Raptor Biphenyl today at
www.restek.com/raptor

Raptor EXP Guard Cartridges—for All Raptor Columns

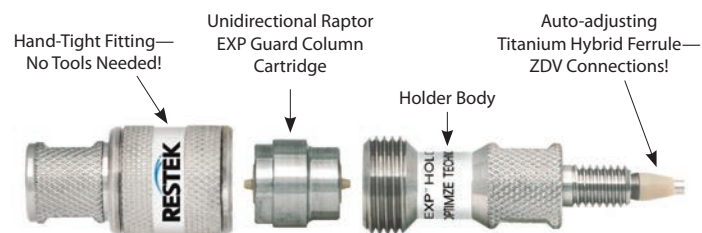

Protect your investment, extend the life of our already-rugged LC columns, and change guard column cartridges by hand without breaking fluid connections—no tools needed! Great with any Raptor column to get ultimate protection from particulates and matrix contamination, especially when using dilute-and-shoot or other minimal sample preparation techniques.

EXP Direct Connect Holder

Description	qty.	cat.#
EXP Direct Connect Holder for EXP Guard Cartridges (includes hex-head fitting & 2 ferrules)	ea.	25808

Maximum holder pressure: 20,000 psi (1,400 bar)

Raptor EXP Guard Column Cartridges

Description	Particle Size	qty.	5 x 2.1 mm cat.#	5 x 3.0 mm cat.#	5 x 4.6 mm cat.#
Raptor Biphenyl EXP Guard Column Cartridge	UHPLC	3-pk.	9309U0252	9309U0253	—
Raptor Biphenyl EXP Guard Column Cartridge	2.7 µm	3-pk.	9309A0252	9309A0253	9309A0250
Raptor Biphenyl EXP Guard Column Cartridge	5 µm	3-pk.	930950252	930950253	930950250

1,034 bar/15,000 psi* (UHPLC), 600 bar/8,700 psi (2.7 µm); 400 bar/5,800 psi (5 µm).

* For maximum lifetime, recommended maximum pressure for 1.8 µm particles is 830 bar/12,000 psi.

Raptor SPP LC columns combine the speed of SPP with the resolution of USLC technology. Learn more at www.restek.com/raptor

UltraShield UHPLC PreColumn Filter—for 1.8 µm Raptor Columns

Pair 1.8 µm Raptor columns with an UltraShield filter instead of a guard cartridge to protect against particulates, minimize extra column volume, and maximize UHPLC sample throughput when using SPE, SLE, or other extensive sample preparations.

Description	Filter Porosity	qty.	cat.#
UltraShield UHPLC PreColumn Filter	0.2 µm frit	ea.	25809
		5-pk.	25810
		10-pk.	25811



Big Pain Assays Aren't a Big Pain with the Raptor Biphenyl LC Column

- 231 compounds, 40+ isobars, 10 drug classes, 22 ESI- compounds in 10 minutes with 1 column.
- A Raptor SPP LC column with time-tested Restek Biphenyl selectivity is the most versatile, multiclass-capable LC column available.
- Achieve excellent separation of critical isobars with no tailing peaks.
- Run fast and reliable high-throughput LC-MS/MS analyses with increased sensitivity using simple mobile phases.

The use of pain management drugs is steadily increasing. As a result, hospital and reference labs are seeing an increase in patient samples that must be screened for a wide variety of pain management drugs to prevent drug abuse and to ensure patient safety and adherence to their medication regimen. Therapeutic drug monitoring can be challenging due to the low cutoff levels, potential matrix interferences, and isobaric drug compounds. To address these challenges, many drug testing facilities are turning to liquid chromatography coupled with mass spectrometry (LC-MS/MS) for its increased speed, sensitivity, and specificity.

As shown in the analysis below, Restek's Raptor Biphenyl column is ideal for developing successful LC-MS/MS pain medication screening methodologies. With its exceptionally high retention and unique selectivity, 231 multiclass drug compounds and metabolites—including over 40 isobars—can be analyzed in just 10 minutes. In addition, separate panels have been optimized on the Raptor Biphenyl column specifically for opioids, antianxiety drugs, barbiturates, NSAIDs and analgesics, antidepressants, antiepileptics, antipsychotics, hallucinogens, and stimulants for use during confirmation and quantitative analyses.

For more information, compound list, and conditions, visit www.restek.com/bigpain

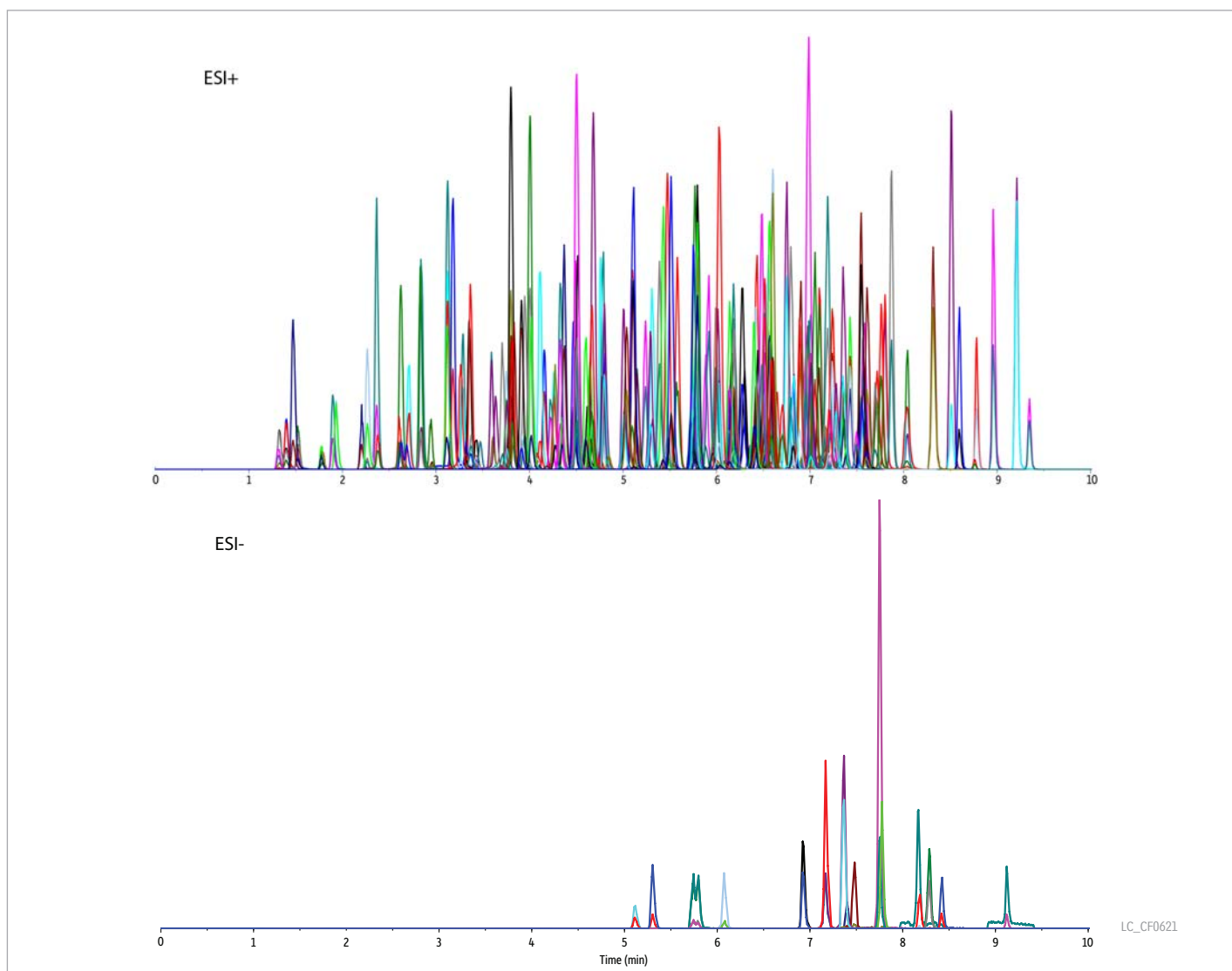

The Raptor ARC-18 Column—Ahead of the Curve for Large, Multiclass Lists by Mass Spec

With Raptor LC columns, Restek chemists became the first to combine the speed of 2.7 and 5 μm superficially porous particles (also known as SPP or “core-shell” particles) with the resolution of highly selective USLC technology, improving separations and speeding up analysis times with standard HPLC instruments. Raptor then evolved to bring that same improved speed, efficiency, and selectivity to UHPLC analyses by offering 1.8 μm particle columns. Learn more about Raptor LC columns at www.restek.com/raptor

The birth of Restek’s Raptor SPP LC column line began with the innovative Biphenyl phase, but it quickly grew to include a new Restek phase: the ARC-18. Designed and intended specifically for use on LC-MS/MS systems, the Raptor ARC-18 column features a well-balanced retention profile without the drawbacks of using an ordinary C18 in the harsh, acidic mobile phases needed for mass spectrometry (MS). Even after extended use in these low-pH (≤ 2.0) conditions, the sterically protected ARC-18 offers consistent retention, peak shape, and response for charged bases, neutral acids, small polar compounds, and more.

For the rapid analysis of large, multiclass assays by LC-MS/MS, the acid-resistant Raptor ARC-18 truly is *ahead of the curve*.

Column Description:



Stationary Phase Category:

C18, octadecylsilane (L1)

Ligand Type:

Sterically protected C18

Particle:

1.8 μm , 2.7 μm , or 5 μm superficially porous silica (SPP or “core-shell”)

Pore Size:

90 Å

Surface Area:

125 m^2/g (1.8 μm),
130 m^2/g (2.7 μm),
or 100 m^2/g (5 μm)

Recommended Usage:

pH Range: 1.0–8.0

Maximum Temperature: 80 °C

Maximum Pressure: 1,034 bar/15,000 psi* (1.8 μm),
600 bar/8,700 psi (2.7 μm); 400 bar/5,800 psi (5 μm)

* For maximum lifetime, recommended maximum pressure for 1.8 μm particles is 830 bar/12,000 psi.

Properties:

- Well-balanced retention profile.
- Sterically protected to resist harsh, low-pH mobile phases.
- Ideal for use with sensitive detectors like mass spec.

Switch to an ARC-18 when:

- You are analyzing large, multiclass lists by LC-MS/MS.
- You require strongly acidic (pH 1–3) mobile phases.

Column Interaction Profile:

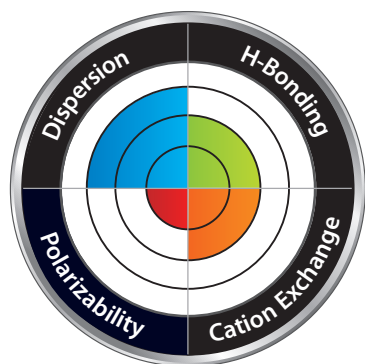

Defining Solute Interaction:

- Dispersion

Complementary Solute Interactions:

- Hydrogen bonding
- Cation exchange

Solute Retention Profile:

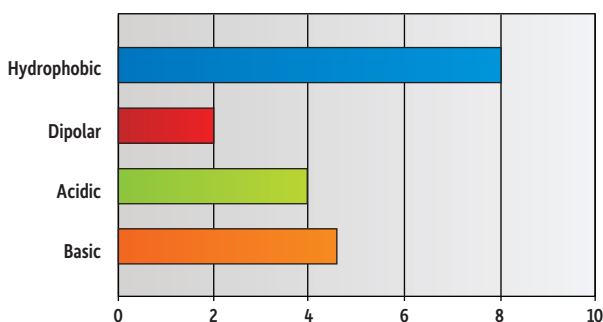

Target Analyte Structure:

- Hydrocarbons

Target Analyte Functionalities:

- Hydrophobic compounds
- Protonated bases

A Proprietary Bonded Phase Born for LC-MS/MS

The Raptor ARC-18 column was designed to stand up to even the harshest acidic MS conditions. It utilizes a proprietary bonding procedure that arranges our sterically protected ligand to resist acid hydrolysis, which reduces phase degradation and bleed. This cutting-edge column lets you increase ionization efficiency and boost sensitivity in your mass spec by using low-pH mobile phases—without the fear of retention drift over time. ARC-18 columns maintain a stable retention profile (Figure 6) in mobile phases well under pH 2.0.

Figure 6: Steric protection helps the Raptor ARC-18 column endure low-pH MS mobile phases without sacrificing retention.

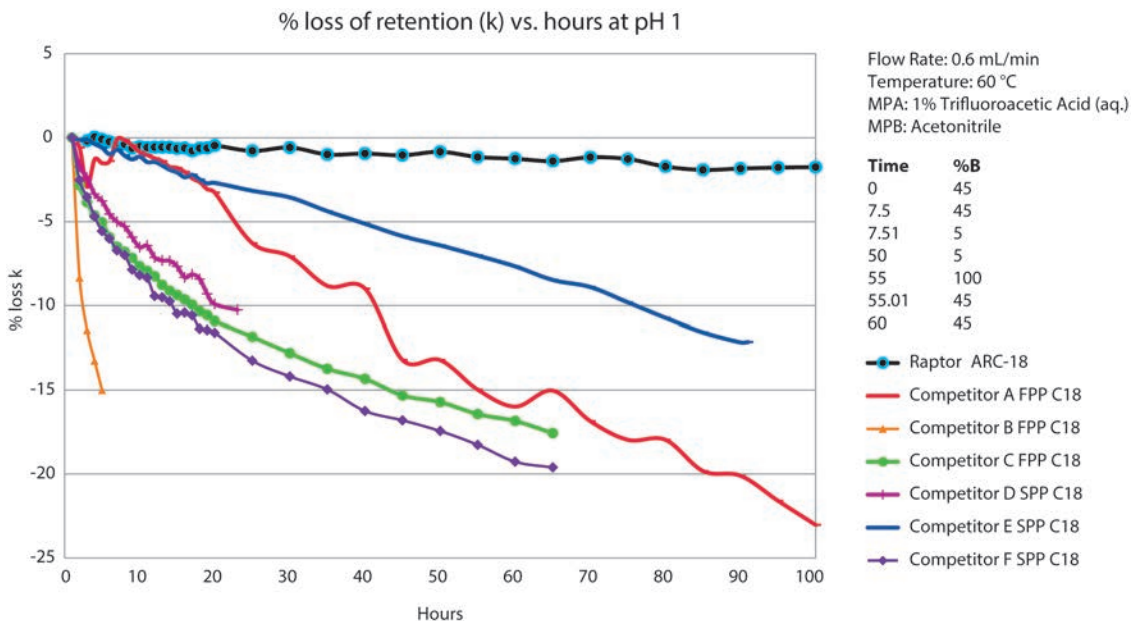

Keep Your LC Work Flowing with Restek Maintenance Supplies

Restek is a 100% employee-owned company and the last major independent provider of chromatography supplies in the industry. We proudly work with every analyst to keep any make or model of LC up and running its best, and our line of 100% guaranteed LC instrument replacement parts meets and often exceeds the original instrument manufacturer's performance. For seals, valves, lamps, and many more OEM-equivalent supplies, simply find your LC manufacturer below to get started.

Agilent LCs: See page 58.

Shimadzu LCs: See page 62.

Waters ACQUITY LCs: See page 65.

Waters Alliance LCs: See page 68.

For other instruments, visit
www.restek.com/LCacc

The Standard for Reproducibility for SPP Core-Shell Columns

To keep your productivity high and your lab expenses low, Raptor ARC-18 columns must produce exceptional selectivity and fast analysis times not just once, but every time. Ruggedness and repeatability are essential, which is why, from the silica and the bonding technique to the packing process and upgraded hardware, every decision that went into creating this column was made to ensure superlative reproducibility, from injection to injection (Figure 7) and from lot to lot (Figure 8). We also adopted new quality control (QC) specifications to guarantee the retention time stability you need for worry-free analyses.

One of the greatest advantages of an SPP column is the ability to operate at higher linear velocities without losing efficiency as you would with a conventional fully porous particle column. But, these higher velocities can also generate higher backpressures that rob you of performance. Like all Raptor columns, our ARC-18 can handle increased pressures and handle them longer than other manufacturers' SPP columns, to help you achieve *Selectivity Accelerated* while offering outstanding reproducibility and maintaining efficiency—even in aggressive MS conditions.

Figure 7: Even after hundreds of injections with a highly acidic mobile phase like 0.2% formic acid, a Raptor ARC-18 column will provide consistent, reliable data.



After 500 injections, pesticide compounds are well within narrow, 15-second MRM windows!

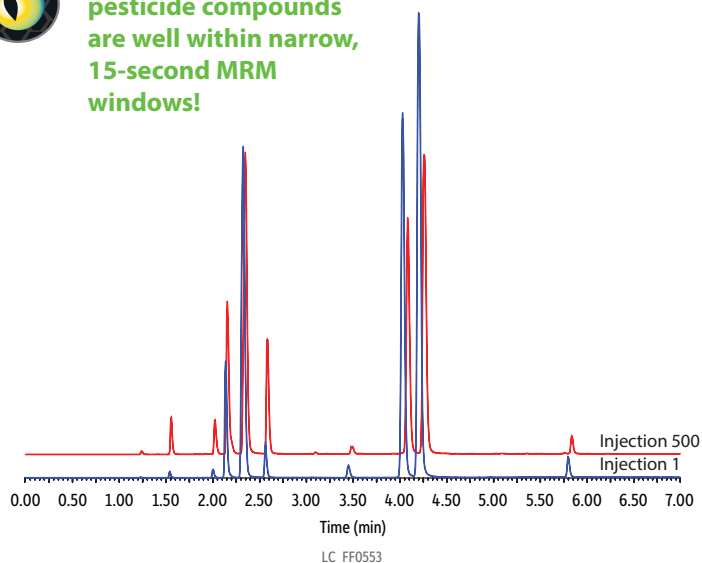

Column: Raptor ARC-18 (cat.# 9314A12); Dimensions: 100 mm x 2.1 mm ID; Particle Size: 2.7 μ m; Temp.: 50 $^{\circ}$ C; **Sample:** LC multiresidue pesticide standard #1 (cat.# 31972); Diluent: Water; Conc.: 20 ng/mL; Inj. Vol.: 5 μ L; **Mobile Phase:** A: Water + 2 mM ammonium formate + 0.2% formic acid, B: Methanol + 2 mM ammonium formate + 0.2% formic acid; **Gradient (%B):** 0.00 min (5%), 2.00 min (60%), 4.00 min (75%), 6.00 min (100%), 7.00 (100%), 7.01 min (5%), 9.50 (5%); **Flow:** 0.4 mL/min; **Detector:** Waters Xevo TQ-S; Ion Source: Waters Zspray ESI; Ion Mode: ESI+; Mode: MRM; **Instrument:** Waters ACQUITY UPLC I-Class.

Figure 8: From one lot to the next, every Raptor ARC-18 column you purchase will perform the same.

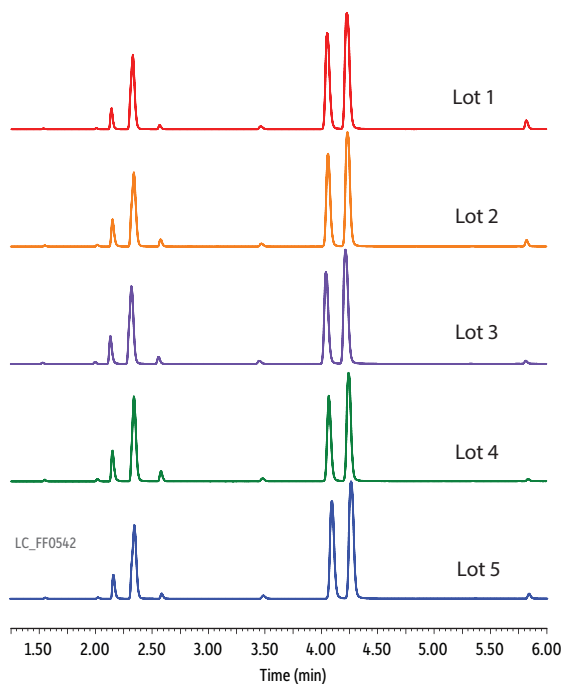

Excellent lot-to-lot reproducibility helps ensure longevity for critical workflows.

Column: Raptor ARC-18 (cat.# 9314A12); Dimensions: 100 mm x 2.1 mm ID; Particle Size: 2.7 μ m; Temp.: 50 $^{\circ}$ C; **Sample:** LC multiresidue pesticide standard #1 (cat.# 31972); Diluent: Water; Conc.: 20 ng/mL; Inj. Vol.: 5 μ L; **Mobile Phase:** A: Water + 2 mM ammonium formate + 0.2% formic acid, B: Methanol + 2 mM ammonium formate + 0.2% formic acid; Max Pressure: 525 bar; **Gradient (%B):** 0.00 min (5%), 2.00 min (60%), 4.00 min (75%), 6.00 min (100%), 7.00 (100%), 7.01 min (5%), 9.50 (5%); **Flow:** 0.4 mL/min; **Detector:** Waters Xevo TQ-S; Ion Source: Waters Zspray ESI; Ion Mode: ESI+; Mode: MRM; **Instrument:** Waters ACQUITY UPLC I-Class.

Speed Up Challenging Analyses with Simple Mobile Phases and Methods

From food safety to bioanalytical work, whether you use traditional HPLC or UHPLC instruments, we're all looking to simplify setup while still getting reliable, reproducible data. Instead of wasting time and resources—and making your job harder in the process—you can greatly improve your productivity by selecting a better column for your existing instrumentation. By switching to a Raptor ARC-18 column for your LC-MS/MS analyses, you can increase your sample throughput and make your job easier by maintaining, or even improving, your data quality using simple mobile phases and method conditions on your existing instrumentation. Put the ARC-18 to work in your lab today to experience *Selectivity Accelerated!*

Amino Acids with Standard Columns on UV or Mass Spec

Instead of purchasing specialty amino acid columns or dedicated analyzers, use Raptor ARC-18 columns with your standard HPLC and UV detector to perform routine analyses of 23 common amino acids. Using 9-fluorenylmethyl-chloroformate (FMOC) derivatization and simple mobile phases, you can separate, detect, and quantitate amino acids without specialty instrumentation (Figure 9). Because of the ARC-18's compatibility with MS-friendly mobile phases, these UV methods can also be easily transferred to your mass spectrometer. And, since it is a Raptor column, it will hold up to extended use without losing selectivity or performance.

Figure 9: Raptor ARC-18 columns exhibit excellent retention and resolution of amino acids derivatized with FMOC, including isomers leucine and isoleucine.

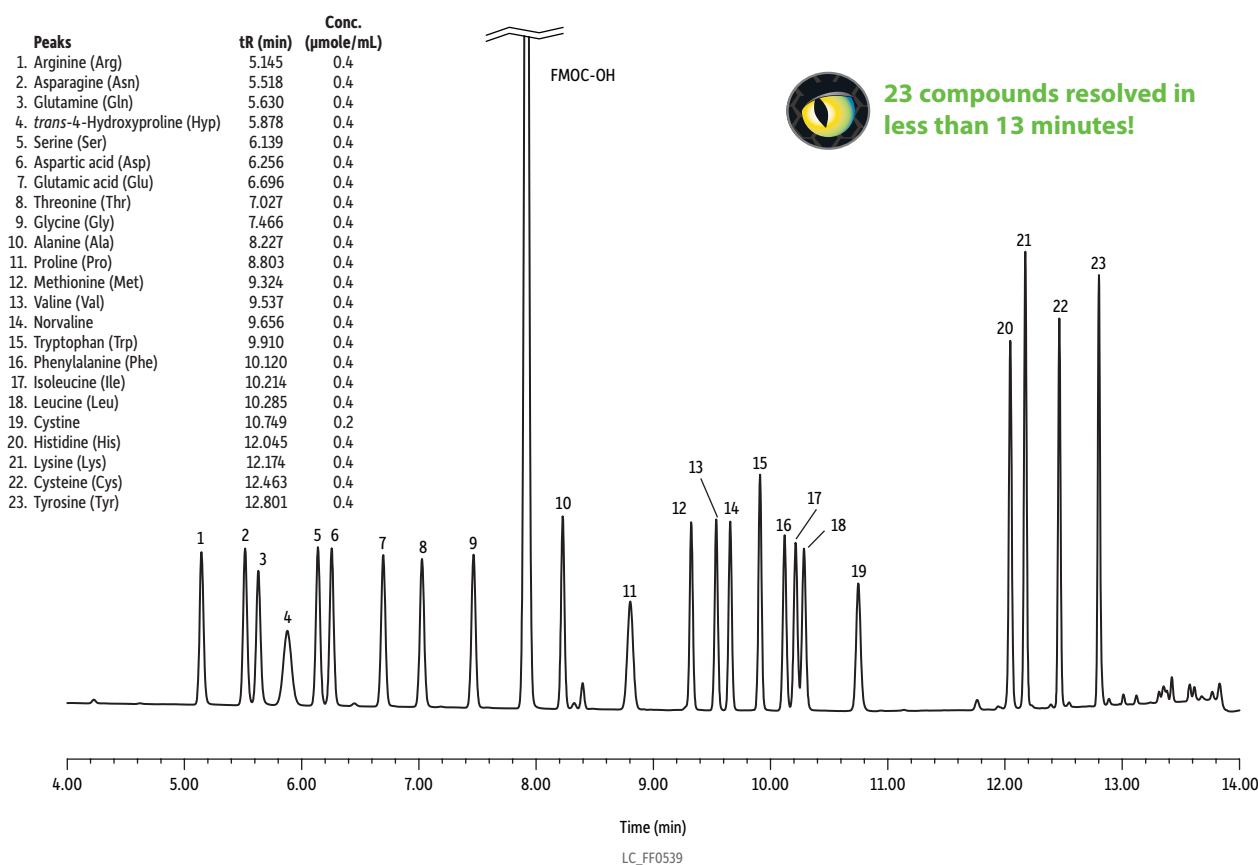

Column: Raptor ARC-18 (cat.# 9314A1E); Dimensions: 100 mm x 3 mm ID; Particle Size: 2.7 μm; Temp.: 30 °C; **Sample:** Diluent: 0.1 N HCl; Conc.: 0.4 μmole/mL for each amino acid (0.2 μmole/mL for cystine); Inj. Vol.: 1 μL; **Mobile Phase:** A: 0.1% Formic acid + 20 mM ammonium formate in water, B: 0.1% Formic acid + 10 mM ammonium formate in 90:10 acetonitrile:water; **Gradient (%B):** 0.00 min (20%), 6.25 min (40%), 9.00 min (60%), 10.00 min (60%), 13.00 (100%), 13.01 min (20%), 15.00 (20%); **Flow:** 0.8 mL/min; **Detector:** UV/Vis @ 265, 4.8 nm; **Instrument:** Waters ACQUITY UPLC H-Class; **Notes:** Derivatization reaction: 50 μL amino acid mix + 100 μL 0.2 N borate buffer (pH 10.0) + 50 μL 15 mM 9-fluorenylmethyl-chloroformate solution + 50 μL acetonitrile; the injection can be performed after 5 minutes of reaction time.

For Consistent Retention, Peak Shape, and Response with Mass Spec, Grab the Column that Thrives in Low pH Conditions

Raptor ARC-18 LC Columns



Length	2.1 mm cat.#	3.0 mm cat.#	4.6 mm cat.#
1.8 µm Columns			
30 mm	9314232	—	—
50 mm	9314252	931425E	—
100 mm	9314212	931421E	—
150 mm	9314262	—	—
2.7 µm Columns			
30 mm	9314A32	9314A3E	9314A35
50 mm	9314A52	9314A5E	9314A55
100 mm	9314A12	9314A1E	9314A15
150 mm	9314A62	9314A6E	9314A65
5 µm Columns			
30 mm	—	931453E	—
50 mm	9314552	931455E	9314555
100 mm	9314512	931451E	9314515
150 mm	9314562	931456E	9314565
250 mm	—	—	9314575

EXP Reusable Fittings for HPLC & UHPLC for 10-32 fittings and 1/16" tubing

Effortlessly achieve 8,700+ psi HPLC seals by hand! (Wrench tighten to 20,000+ psi.) Hybrid titanium/PEEK seal can be installed repeatedly without compromising your seal.



Description	qty.	cat.#
EXP Hand-Tight Fitting (Nut w/Ferrule)	ea.	25937
EXP Hand-Tight Fitting (Nut w/Ferrule)	10-pk.	25938
EXP Hand-Tight Nut (w/o Ferrule)	ea.	25939

Hybrid Ferrule U.S. Patent No. 8201854, Optimize Technologies. EXP Holders U.S. Patent No. 8696902, Optimize Technologies. EXP2 wrench U.S. Patent No. D766055, Optimize Technologies. Other U.S. and Foreign Patents Pending. The Opti- prefix is a registered trademark of Optimize Technologies, Inc.

Experience *Selectivity Accelerated*.
Order the Raptor ARC-18 today at
www.restek.com/raptor

Raptor EXP Guard Cartridges—for All Raptor Columns

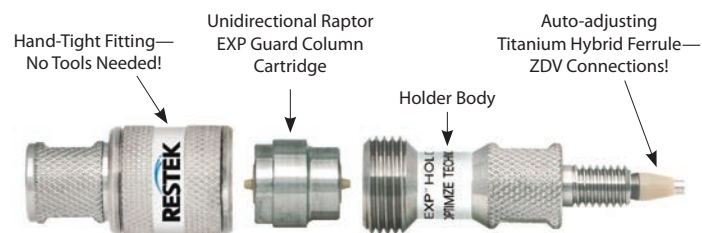

Protect your investment, extend the life of our already-rugged LC columns, and change guard column cartridges by hand without breaking fluid connections—no tools needed! Great with any Raptor column to get ultimate protection from particulates and matrix contamination, especially when using dilute-and-shoot or other minimal sample preparation techniques.

EXP Direct Connect Holder

Description	qty.	cat.#
EXP Direct Connect Holder for EXP Guard Cartridges (includes hex-head fitting & 2 ferrules)	ea.	25808

Maximum holder pressure: 20,000 psi (1,400 bar)

Raptor EXP Guard Column Cartridges

Description	Particle Size	qty.	5 x 2.1 mm cat.#	5 x 3.0 mm cat.#	5 x 4.6 mm cat.#
Raptor ARC-18 EXP Guard Column Cartridge	UHPLC	3-pk.	9314U0252	9314U0253	
Raptor ARC-18 EXP Guard Column Cartridge	2.7 µm	3-pk.	9314A0252	9314A0253	9314A0250
Raptor ARC-18 EXP Guard Column Cartridge	5 µm	3-pk.	931450252	931450253	931450250

1,034 bar/15,000 psi* (UHPLC), 600 bar/8,700 psi (2.7 µm); 400 bar/5,800 psi (5 µm).
* For maximum lifetime, recommended maximum pressure for 1.8 µm particles is 830 bar/12,000 psi.

Raptor SPP LC columns combine the speed of SPP with the resolution of USLC technology. Learn more at www.restek.com/raptor

UltraShield UHPLC PreColumn Filter—for 1.8 µm Raptor Columns

Pair 1.8 µm Raptor columns with an UltraShield filter instead of a guard cartridge to protect against particulates, minimize extra column volume, and maximize UHPLC sample throughput when using SPE, SLE, or other extensive sample preparations.

Description	Filter Porosity	qty.	cat.#
UltraShield UHPLC PreColumn Filter	0.2 µm frit	ea.	25809
		5-pk.	25810
		10-pk.	25811



The Raptor FluoroPhenyl Column—Get the Power of HILIC and RP Modes in One LC Column

With Raptor LC columns, Restek chemists became the first to combine the speed of 2.7 and 5 μm superficially porous particles (also known as SPP or “core-shell” particles) with the resolution of highly selective USLC technology, improving separations and speeding up analysis times with standard HPLC instruments. Raptor then evolved to bring that same improved speed, efficiency, and selectivity to UHPLC analyses by offering 1.8 μm particle columns. Learn more about Raptor LC columns at www.restek.com/raptor

With the addition of Raptor FluoroPhenyl columns, Restek further expanded the speed and reliability of Raptor column technology into the HILIC realm. Restek’s Raptor FluoroPhenyl phase offers chromatographers the ability to run in reversed-phase or HILIC mode for a variety of compounds. The Restek Raptor FluoroPhenyl column is also amenable to LC-MS because it is extremely reliable and efficient with acidic mobile phases.

Switch to a Raptor FluoroPhenyl LC column for reliable performance in *both* reversed-phase and HILIC modes.

Column Description:

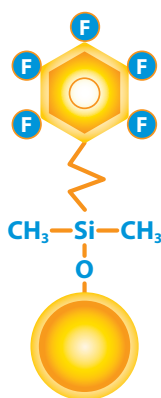

Stationary Phase Category:
Pentafluorophenyl propyl (L43)

Ligand Type:
Fluorophenyl

Particle:
1.8 μm , 2.7 μm , or 5 μm superficially porous silica (SPP or “core-shell”)

Pore Size:
90 Å

Surface Area:
125 m^2/g (1.8 μm),
130 m^2/g (2.7 μm),
or 100 m^2/g (5 μm)

Recommended Usage:

pH Range: 2.0–8.0

Maximum Temperature: 80 °C

Maximum Pressure: 1,034 bar/15,000 psi* (1.8 μm),
600 bar/8,700 psi (2.7 μm); 400 bar/5,800 psi (5 μm)

* For maximum lifetime, recommended maximum pressure for 1.8 μm particles is 830 bar/12,000 psi.

Properties:

- Capable of both reversed-phase and HILIC separations.
- Ideal for increasing sensitivity and selectivity in LC-MS analyses.
- Offers increased retention for charged bases.

Switch to a Raptor FluoroPhenyl LC column when:

- You observe limited retention and selectivity on a C18 for basic compounds.
- You need increased retention of hydrophilic compounds.

Column Interaction Profile:

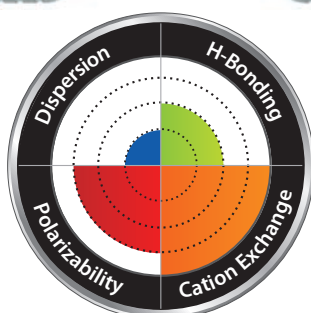

Defining Solute Interaction:

- Cation exchange

Complementary Solute Interactions:

- Polarizability
- Dispersion

Solute Retention Profile:

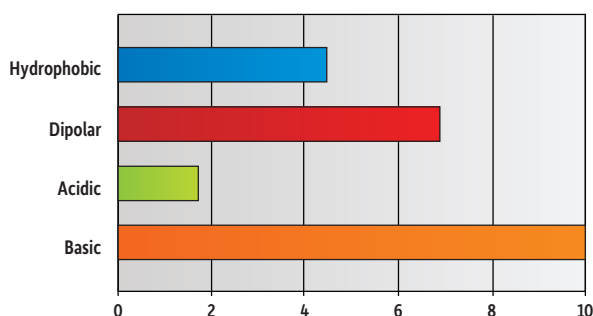

Target Analyte Structures:

- Nitrogen-containing

Target Analyte Functionalities:

- Protonated amines
- Quaternary ammonium compounds
- Positively charged moieties
- Lewis bases

Raptor FluoroPhenyl Columns: Rugged, Check—Reproducible, Double Check.

Of course, Raptor FluoroPhenyl columns are rugged; that is to be expected. And, they are exceptionally reproducible as well. Reproducibility can be an issue for fluorinated phenyl phases, which is why we engineered all our columns for dependable performance. Lot to lot, column to column, and injection to injection, every Raptor FluoroPhenyl column gives a consistent performance that you can count on: consider it done.

Figure 10: Raptor FluoroPhenyl columns maintain efficiency in any dimension or particle size—even at their maximum recommended operating pressures—so you can run at high linear velocities with confidence.

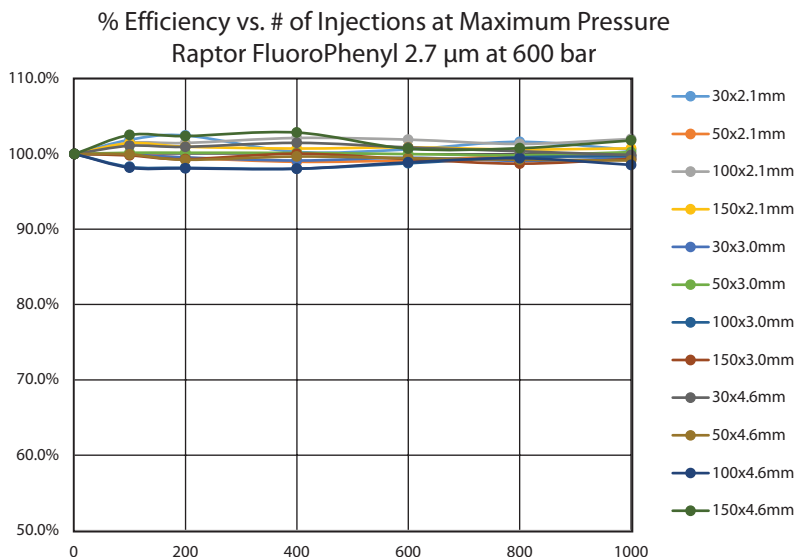
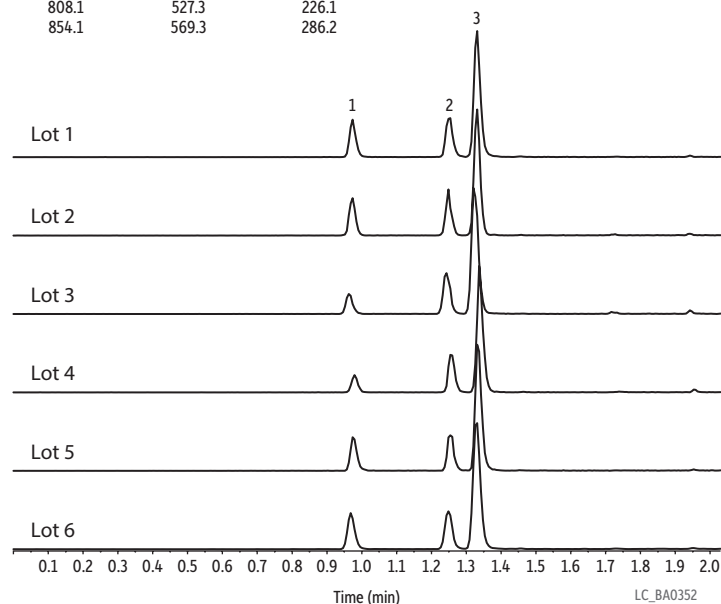

Figure 11: Strict quality control ensures Raptor FluoroPhenyl columns are exceptionally reproducible, so you get predictable performance from every column.



Reliable, reproducible fluorophenyl column performance.

Peaks	t _R (min)	Precursor Ion	Product Ion 1	Product Ion 2
1. Baccatin III	0.97	587.0	405.1	105.0
2. Docetaxel	1.25	808.1	527.3	226.1
3. Paclitaxel	1.33	854.1	569.3	286.2



Column: Raptor FluoroPhenyl (cat.# 931955E); Dimensions: 50 mm x 3 mm ID, Particle Size: 5 µm; Temp.: 35 °C; Sample: Diluent: Water; Conc.: 100 ng/mL; Inj. Vol.: 5 µL; Mobile Phase: A: 0.1% Formic acid in water; B: 0.1% Formic acid in acetonitrile; Gradient (%B): 0.00 min (25% B), 2.00 (95% B), 2.01 (25% B), 3.50 (25% B); Flow: 0.8 mL/min; Detector: MS/MS; Ion Mode: ESI+; Mode: MRM; Instrument: UHPLC.

More Separating Power than a C18

C18 columns work well for many compounds, but they just don't work for everything. Raptor FluoroPhenyl columns can provide greater selectivity and retention for analytes that are not easily separated by C18 phase chemistry. For example, interest in vitamin D status is on the rise in clinical diagnostics, but accurate analysis is only possible if the epimeric forms of both vitamin D2 and D3 25-hydroxy metabolites can be distinguished. Typical reversed-phase C18 columns cannot separate these isobaric epimers, which differ in bioactivity, but the new Raptor FluoroPhenyl column provides adequate chromatographic resolution so accurate results are generated and the proper diagnosis can be made.

Figure 12: Reversed-phase C18 columns do not have the right selectivity or retention mechanism to separate the epimers of vitamin D2 and D3 25-hydroxy metabolites.

Epimers do not separate on a C18, even in a 14-minute analysis time.

Peaks	MRM	t _R	Conc. (ng/mL)
1. 25-Hydroxyvitamin D3	401.5/383.4	9.36	50
2. 3-Epi-25-hydroxyvitamin D3	401.5/383.4	9.36	25

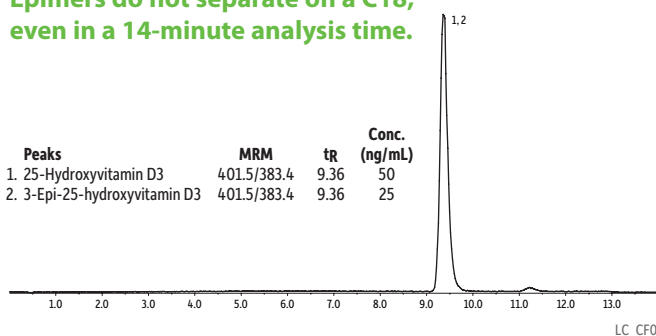

Peaks	MRM	t _R	Conc. (ng/mL)
1. 25-Hydroxyvitamin D2	413.5/355.5	10.38	50
2. 3-Epi-25-hydroxyvitamin D2	413.5/355.5	10.38	25

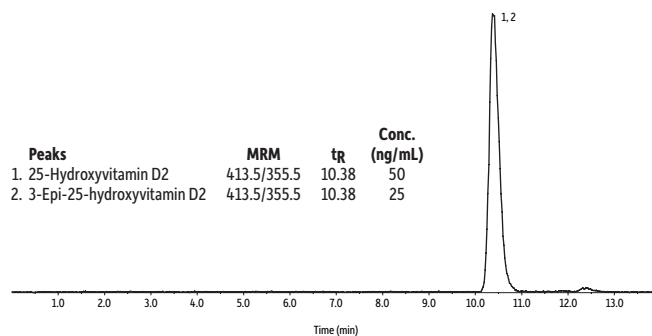

Column: Raptor ARC-18 (cat.# 9314A12); Dimensions: 100 mm x 2.1 mm ID, Particle Size: 2.7 µm; Temp.: 30 °C; **Sample:** Diluent: Water:methanol (50:50); Conc.: 25-50 ng/mL; Inj. Vol.: 5 µL; **Mobile Phase:** A: 0.1% Formic acid in water; B: Methanol; **Gradient (%B):** 0.00 min (75% B), 4.00 (80% B), 12.00 (80% B), 12.10 (75% B), 14.00 (75% B); **Flow:** 0.5 mL/min; **Detector:** MS/MS; Ion Mode: ESI+; Mode: MRM; **Instrument:** HPLC.

Figure 13: Raptor FluoroPhenyl columns have the selectivity and retention you need to quickly and easily separate compounds that coelute on a C18, such as the epimeric forms of vitamin D2 and D3 25-hydroxy metabolites.



Raptor FluoroPhenyl columns easily separate compounds that coelute on a C18.

Peaks	MRM	t _R	Conc. (ng/mL)
1. 25-Hydroxyvitamin D3	401.5/383.4	3.59	50
2. 3-Epi-25-hydroxyvitamin D3	401.5/383.4	3.78	25

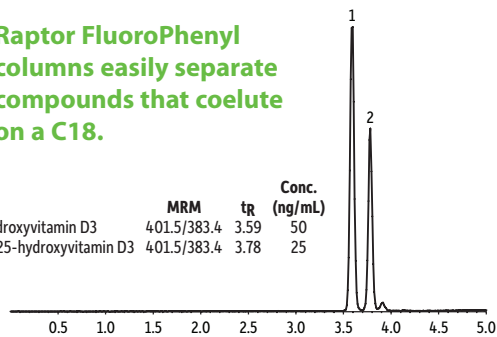

Peaks	MRM	t _R	Conc. (ng/mL)
1. 25-Hydroxyvitamin D2	413.5/355.5	3.73	50
2. 3-Epi-25-hydroxyvitamin D2	413.5/355.5	3.91	25

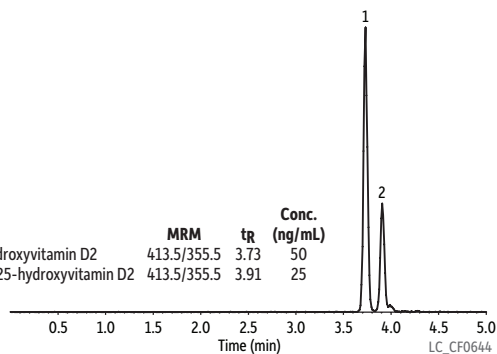

Raptor reproducibility lets you develop assays with confidence.



Column: Raptor FluoroPhenyl (cat.# 9319A1E); Dimensions: 100 mm x 3 mm ID, Particle Size: 2.7 µm; Temp.: 30 °C; **Sample:** Diluent: Water:methanol (50:50); Conc.: 25-50 ng/mL; Inj. Vol.: 5 µL; **Mobile Phase:** A: 0.1% Formic acid in water; B: Methanol; **Gradient (%B):** 0.00 min (75% B), 4.00 (85% B), 4.10 (100% B), 5.00 (100% B), 5.01 (75% B), 7.00 (75% B); **Flow:** 0.6 mL/min; **Detector:** MS/MS; Ion Mode: ESI+; Mode: MRM; **Instrument:** HPLC.

Get the Power of HILIC and RP Modes in One LC Column

HILIC chromatography is becoming the go-to solution for compounds that are difficult to retain on a C18. The Raptor FluoroPhenyl column gives chromatographers the flexibility to evaluate compound retention in both reversed-phase and HILIC modes. The analysis of 4-methylimidazole (4-MEI), which is a byproduct of caramel coloring in foods and beverages, can be problematic by reversed-phase chromatography due to very limited retention. However, 4-MEI is well retained on a Raptor FluoroPhenyl column and can easily be analyzed using HILIC mode and simple LC and LC-MS/MS compatible mobile phases.

Figure 14: Sometimes, adequate retention cannot be obtained with a C18. The Raptor FluoroPhenyl column performs dependably in either HILIC or RP mode, so you can use the mode that is best for your analytes.



Raptor FluoroPhenyl columns give you the flexibility to work in both reversed-phase and HILIC modes.

Peaks	tr (min)	Precursor Ion	Product Ion
1. 4-Methylimidazole (4-MEI)	1.19	83	56

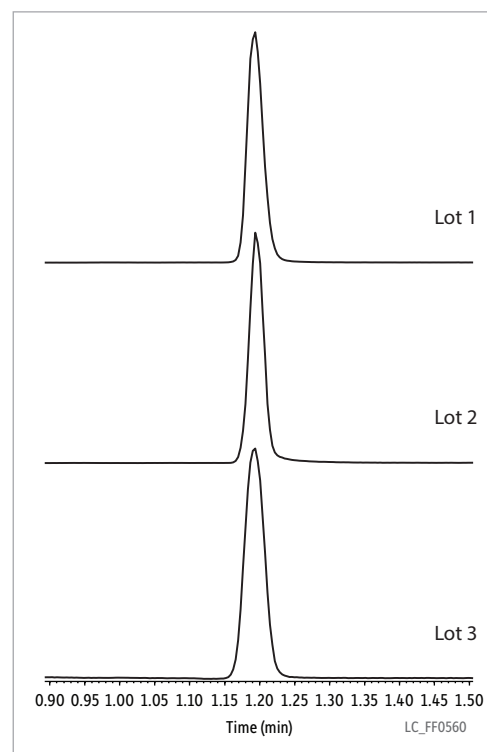
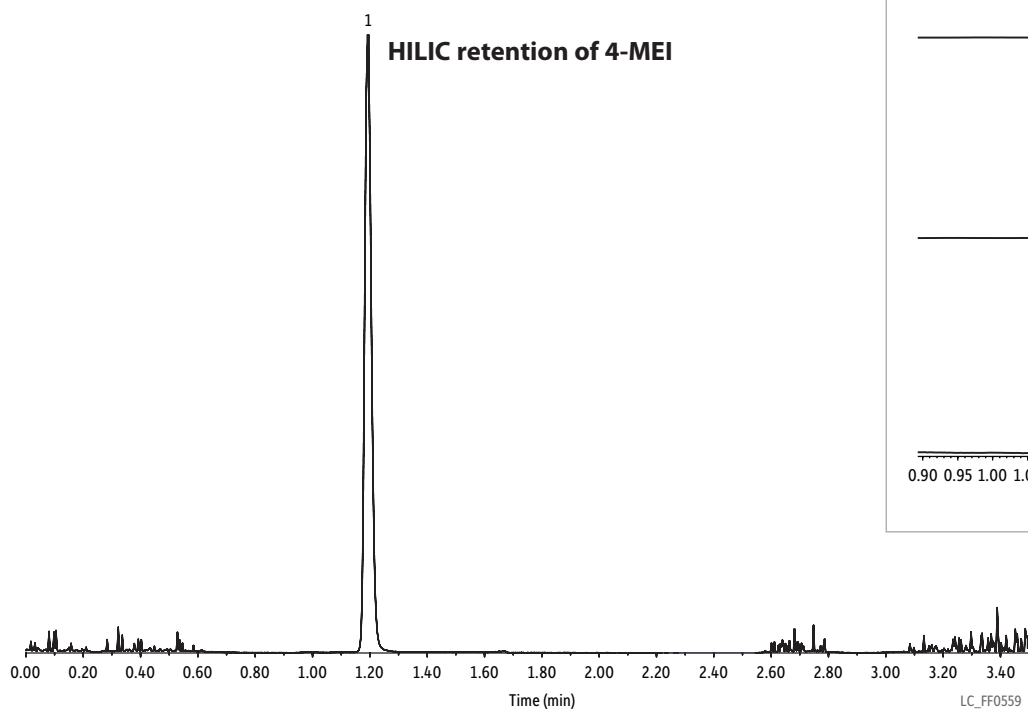

Column: Raptor FluoroPhenyl (cat.# 9319A52); Dimensions: 50 mm x 2.1 mm ID; Particle Size: 2.7 μ m; Temp.: 35 $^{\circ}$ C; **Sample:** Diluent: Acetonitrile; Conc.: 100 ng/mL; Inj. Vol.: 5 μ L; **Mobile Phase:** A: 0.1% Formic acid in water; B: 0.1% Formic acid in acetonitrile; **Gradient (%B):** 0.00 min (95% B), 2.00 (30% B), 2.01 (95% B), 3.50 (95% B); **Flow:** 0.6 mL/min; **Detector:** MS/MS; Ion Mode: ESI+; Mode: MRM; **Instrument:** UHPLC.

Exceptional Selectivity for Clinical Analyses

The analysis of normetanephrine and metanephrine provides another example of the power of Raptor FluoroPhenyl columns for analyzing basic compounds. Accurately determining these metabolites of epinephrine/norepinephrine in plasma or urine is one of the best diagnostic tests for neuroendocrine tumors (pheochromocytomas). Normetanephrine and metanephrine are difficult to retain by typical C18 reversed-phase chromatography; however, the Raptor FluoroPhenyl column provides a simple, fast chromatographic solution to this challenging assay. The Raptor FluoroPhenyl column's unique combination of aromatic retention and cation exchange mechanisms are not provided by a C18 column and result in reliable, high-quality separations.

Figure 15: Rapid analysis of metanephrine and normetanephrine on a Raptor FluoroPhenyl column.

Peaks	tr (min)	Precursor Ion	Product Ion 1	Product Ion 2
1. Normetanephrine	1.15	166.1	121.1	134.0
2. Metanephrine	1.52	180.1	165.1	148.3

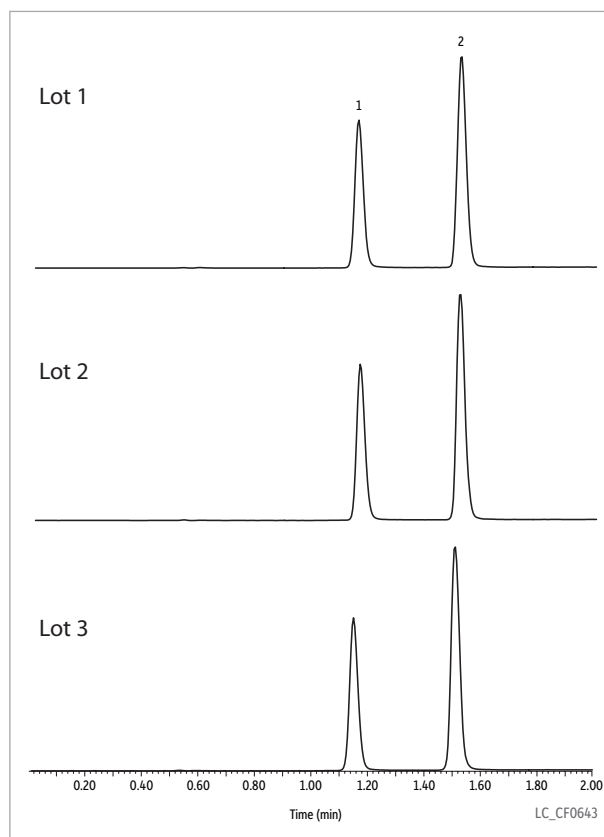
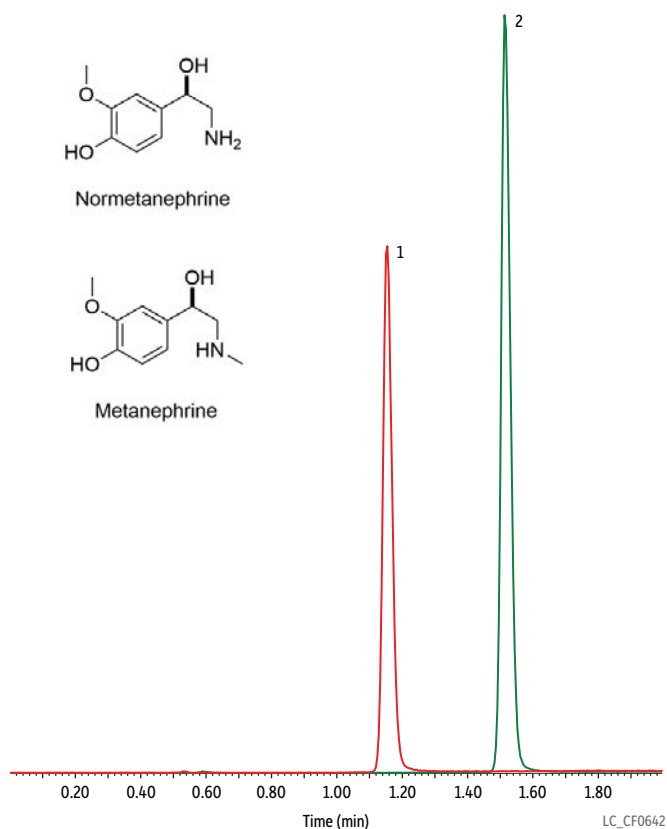
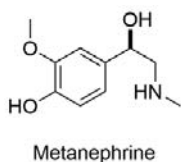
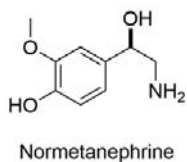

Column: Raptor FluoroPhenyl (cat.# 9319A12); Dimensions: 100 mm x 2.1 mm ID; Particle Size: 2.7 μ m; Temp.: 30 $^{\circ}$ C; **Sample:** Diluent: Water; Conc.: 20 ng/mL; Inj. Vol.: 5 μ L; **Mobile Phase:** A: 0.2% Formic acid in water; B: Methanol; **Gradient (%B):** 0.00 min (2% B), 2.00 (40% B), 2.01 (2% B), 6.00 (2% B); Flow: 0.4 mL/min; **Detector:** MS/MS; Ion Mode: ESI+; Mode: MRM; **Instrument:** UHPLC.

Dependable Raptor FluoroPhenyl Columns Give You the Flexibility to Use Both HILIC and RP Modes

Raptor FluoroPhenyl LC Columns (USP L43)



Length	2.1 mm cat.#	3.0 mm cat.#	4.6 mm cat.#
1.8 µm Columns			
30 mm	9319232	—	—
50 mm	9319252	931925E	—
100 mm	9319212	931921E	—
150 mm	9319262	—	—
2.7 µm Columns			
30 mm	9319A32	9319A3E	9319A35
50 mm	9319A52	9319A5E	9319A55
100 mm	9319A12	9319A1E	9319A15
150 mm	9319A62	9319A6E	9319A65
5 µm Columns			
30 mm	—	931953E	—
50 mm	9319552	931955E	9319555
100 mm	9319512	931951E	9319515
150 mm	9319562	931956E	9319565
250 mm	—	—	9319575

EXP Reusable Fittings for HPLC & UHPLC for 10-32 fittings and 1/16" tubing

Effortlessly achieve 8,700+ psi HPLC seals by hand! (Wrench tighten to 20,000+ psi.) Hybrid titanium/PEEK seal can be installed repeatedly without compromising your seal.



Description	qty.	cat.#
EXP Hand-Tight Fitting (Nut w/Ferrule)	ea.	25937
EXP Hand-Tight Fitting (Nut w/Ferrule)	10-pk.	25938
EXP Hand-Tight Nut (w/o Ferrule)	ea.	25939

Hybrid Ferrule U.S. Patent No. 8201854, Optimize Technologies. EXP Holders U.S. Patent No. 8696902, Optimize Technologies. EXP2 wrench U.S. Patent No. D766055, Optimize Technologies. Other U.S. and Foreign Patents Pending. The Opti- prefix is a registered trademark of Optimize Technologies, Inc.

Experience *Selectivity Accelerated*. Order the Raptor FluoroPhenyl today at www.restek.com/raptor

Raptor EXP Guard Cartridges—for All Raptor Columns

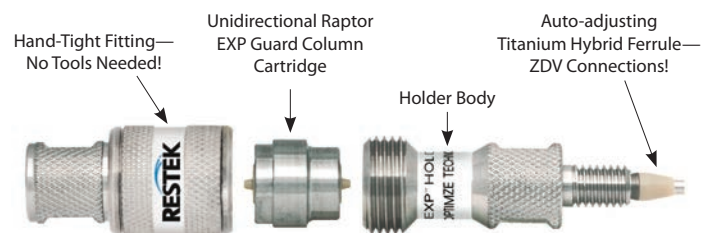

Protect your investment, extend the life of our already-rugged LC columns, and change guard column cartridges by hand without breaking fluid connections—no tools needed! Great with any Raptor column to get ultimate protection from particulates and matrix contamination, especially when using dilute-and-shoot or other minimal sample preparation techniques.

EXP Direct Connect Holder

Description	qty.	cat.#
EXP Direct Connect Holder for EXP Guard Cartridges (includes hex-head fitting & 2 ferrules)	ea.	25808

Maximum holder pressure: 20,000 psi (1,400 bar)

Raptor EXP Guard Column Cartridges

Description	Particle Size	qty.	5 x 2.1 mm cat.#	5 x 3.0 mm cat.#	5 x 4.6 mm cat.#
Raptor FluoroPhenyl EXP Guard Column Cartridge	UHPLC	3-pk.	9319U0252	9319U0253	
Raptor FluoroPhenyl EXP Guard Column Cartridges	2.7 µm	3-pk.	9319A0252	9319A0253	9319A0250
Raptor FluoroPhenyl EXP Guard Column Cartridges	5 µm	3-pk.	931950252	931950253	931950250

1,034 bar/15,000 psi* (UHPLC), 600 bar/8,700 psi (2.7 µm); 400 bar/5,800 psi (5 µm).
* For maximum lifetime, recommended maximum pressure for 1.8 µm particles is 830 bar/12,000 psi.

Raptor SPP LC columns combine the speed of SPP with the resolution of USLC technology. Learn more at www.restek.com/raptor

UltraShield UHPLC PreColumn Filter—for 1.8 µm Raptor Columns

Pair 1.8 µm Raptor columns with an UltraShield filter instead of a guard cartridge to protect against particulates, minimize extra column volume, and maximize UHPLC sample throughput when using SPE, SLE, or other extensive sample preparations.

Description	Filter Porosity	qty.	cat.#
UltraShield UHPLC PreColumn Filter	0.2 µm frit	ea.	25809
		5-pk.	25810
		10-pk.	25811



The Raptor C18 Column—Raptor Speed, Efficiency, and Ruggedness in C18

With Raptor LC columns, Restek chemists became the first to combine the speed of 2.7 and 5 μm superficially porous particles (also known as SPP or “core-shell” particles) with the resolution of highly selective USLC technology, improving separations and speeding up analysis times with standard HPLC instruments. Raptor then evolved to bring that same improved speed, efficiency, and selectivity to UHPLC analyses by offering 1.8 μm particle columns. Learn more about Raptor LC columns at www.restek.com/raptor

Even though every LC lab has a cache of C18s, not all C18s are created equal. Because the chemistry tends to be similar, the silica support that carries this ubiquitous octadecylsilane phase becomes vitally important. When you need a general-purpose LC column, don't just grab any C18. Choose the speed, efficiency, and long-lasting ruggedness of the Raptor C18 SPP LC column.

The traditional end-capped Raptor C18 offers the highest hydrophobic retention of any Raptor phase, and it is compatible with a wide range of mobile phases from moderately acidic to neutral (pH 2–8). Whether for food safety, environmental, or bioanalytical analyses, this phase offers consistently excellent data quality in less time across myriad reversed-phase applications, matrices, and compound classes.

Column Description:

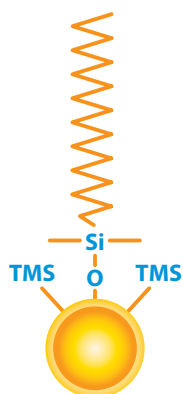

Stationary Phase Category:

C18, octadecylsilane (L1)

Ligand Type:

End-capped C18

Particle:

1.8 μm , 2.7 μm , or 5 μm superficially porous silica (SPP or “core-shell”)

Pore Size:

90 Å

Surface Area:

125 m^2/g (1.8 μm),
130 m^2/g (2.7 μm),
or 100 m^2/g (5 μm)

Recommended Usage:

pH Range: 2.0–8.0

Maximum Temperature: 80 °C

Maximum Pressure: 1,034 bar/15,000 psi* (1.8 μm),
600 bar/8,700 psi (2.7 μm); 400 bar/5,800 psi (5 μm)

* For maximum lifetime, recommended maximum pressure for 1.8 μm particles is 830 bar/12,000 psi.

Properties:

- Compatible with moderately acidic to neutral mobile phases (pH 2–8).
- Excellent data quality in food, environmental, bioanalytical, and other applications.

Switch to a C18 when:

- You need a general-purpose column for reversed-phase chromatography.
- You need to increase retention of hydrophobic compounds.

Column Interaction Profile:

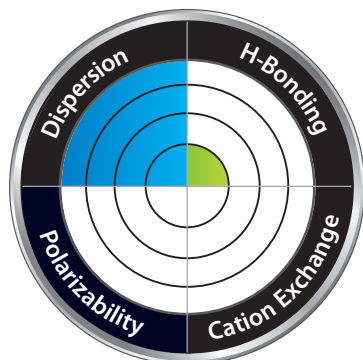

Defining Solute Interaction:

- Dispersion

Solute Retention Profile:

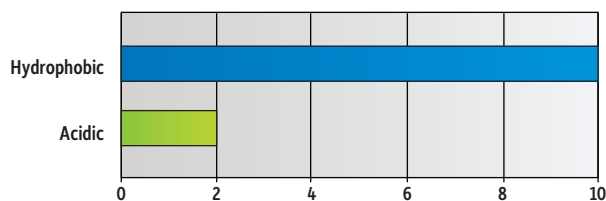

Target Analyte Structure:

- Hydrocarbons

Target Analyte Functionalities:

- Hydrophobic compounds

Raptor C18 Performance: Speed, Efficiency, and Ruggedness in Action

Raptor C18 columns provide outstanding dependability and data quality with high efficiency and peak symmetry, and they are built to exacting specifications that make your columns exceptionally consistent and improve their lifetime. To lower costs and improve profitability, you need columns to last longer, data to be reproducible, and existing HPLC instrumentation to run faster. Get there with the only general-purpose C18 that gives you *Selectivity Accelerated*.

Figure 16: Comparing 50 mm x 2.1 mm sub-2 µm C18 columns, Raptor columns maintain reliable performance past 1,000 injections, consistently matching or beating the competition.

Expect consistently high performance over 1,000 injections

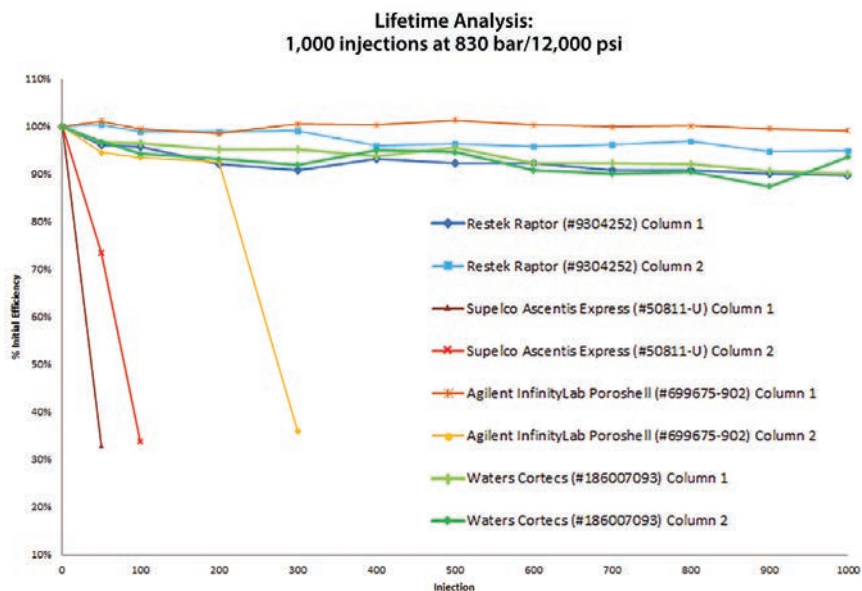
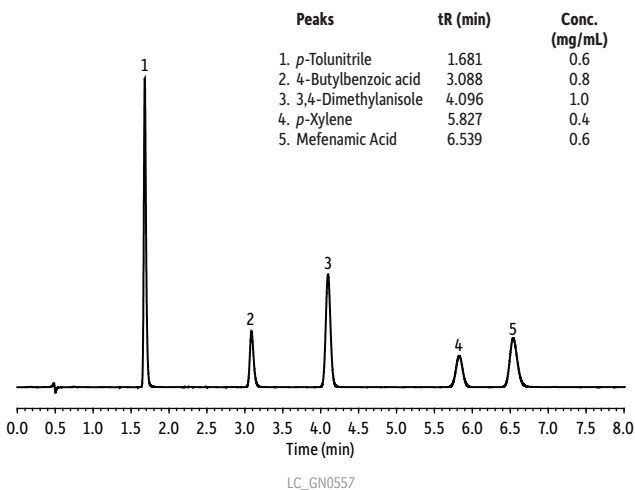

Figure 17: Raptor columns' stringent quality control (QC) specifications guarantee outstanding peak shape, even with active compounds, for superior data quality.

Outstanding peak shapes for top-notch data



Column: Raptor C18 (cat.# 9304A1E); Dimensions: 100 mm x 3 mm ID; Particle Size: 2.7 µm; Pore Size: 90 Å; Temp.: 30 °C; **Sample:** Diluent: Acetonitrile:water:phosphoric acid (65:34:1); Inj. Vol.: 1 µL; **Mobile Phase:** A: 0.05% Formic acid in water, B: 0.05% Formic acid in acetonitrile; **Gradient (%B):** 0.00 min (45% B), 8.00 min (45% B); **Flow:** 0.8 mL/min; **Detector:** UV/Vis @ 220 nm; Cell Temp.: 40 °C; **Instrument:** HPLC.

Figure 18: Lot-to-lot reproducibility is the key to keeping your productivity high and budget low. You can expect the same exceptional performance from every Raptor C18 column you purchase.

Lot-to-lot reproducibility for fast, reliable results every time

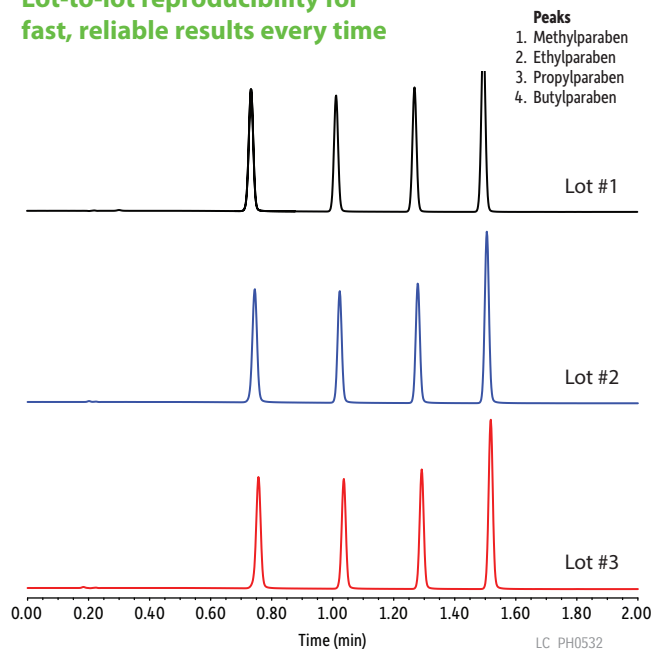

Column: Raptor C18 (cat.# 9304512); Dimensions: 100 mm x 2.1 mm ID; Particle Size: 5 µm; Temp.: 40 °C; **Sample:** Conc.: 100 µg/mL in water; Inj. Vol.: 1 µL; **Mobile Phase:** A: Water, B: Acetonitrile; **Gradient (%B):** 0.00 min (20% B), 2.00 min (80% B), 2.01 min (20% B), 3.50 min (20% B); **Flow:** 1.0 mL/min; **Detector:** PDA @ 254 nm; **Instrument:** UHPLC.

Boost Your Productivity with Raptor C18 Columns

When developing an assay, it is important to consider how productive your method will be. Because superficially porous, or “core-shell,” particles are well known for very high efficiency with minimal backpressure, they are ideal for decreasing analysis time (Figure 19). With its general-purpose applicability and SPP core-shell particles, the Raptor C18 column lets you quickly develop faster methods, thereby boosting your productivity.

Figure 19: SPP particles, like those in the Raptor C18 column, are one important step towards total method optimization.

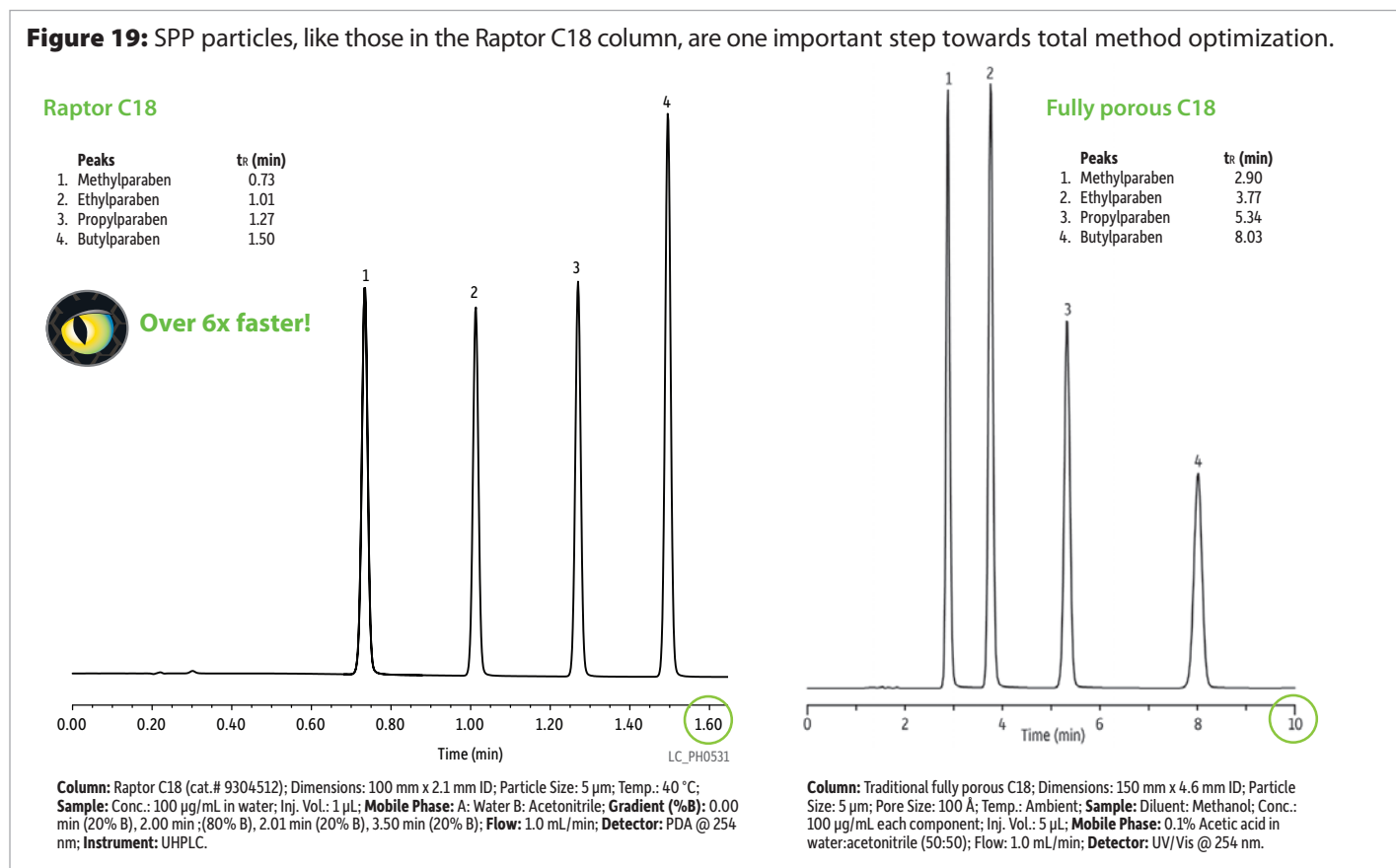

QuEChERS Made Even Easier

New free-flowing Q-sep salts in slim packets make extraction a snap!

- Free-flowing salts transfer easily and completely.
- Easy-open packets eliminate the need for a second empty tube for salt transfer.
- Convenient slim packets fit perfectly into tubes to prevent spills.

www.restek.com/quechers



Lower Costs and Improve Profitability with the Only General-Purpose C18 That Gives You *Selectivity Accelerated*

Raptor C18 LC Columns (USP L1)



Length	2.1 mm cat.#	3.0 mm cat.#	4.6 mm cat.#
1.8 µm Columns			
30 mm	9304232	—	—
50 mm	9304252	930425E	—
100 mm	9304212	930421E	—
150 mm	9304262	—	—
2.7 µm Columns			
30 mm	9304A32	9304A3E	9304A35
50 mm	9304A52	9304A5E	9304A55
100 mm	9304A12	9304A1E	9304A15
150 mm	9304A62	9304A6E	9304A65
5 µm Columns			
30 mm	—	930453E	—
50 mm	9304552	930455E	9304555
100 mm	9304512	930451E	9304515
150 mm	9304562	930456E	9304565
250 mm	—	—	9304575

EXP Reusable Fittings for HPLC & UHPLC for 10-32 fittings and 1/16" tubing

Effortlessly achieve 8,700+ psi HPLC seals by hand! (Wrench tighten to 20,000+ psi.) Hybrid titanium/PEEK seal can be installed repeatedly without compromising your seal.



Description	qty.	cat.#
EXP Hand-Tight Fitting (Nut w/Ferrule)	ea.	25937
EXP Hand-Tight Fitting (Nut w/Ferrule)	10-pk.	25938
EXP Hand-Tight Nut (w/o Ferrule)	ea.	25939

Hybrid Ferrule U.S. Patent No. 8201854, Optimize Technologies. EXP Holders U.S. Patent No. 8696902, Optimize Technologies. EXP2 wrench U.S. Patent No. D766055, Optimize Technologies. Other U.S. and Foreign Patents Pending. The Opti- prefix is a registered trademark of Optimize Technologies, Inc.

Experience *Selectivity Accelerated*.
Order the Raptor C18 today at
www.restek.com/raptor

Raptor EXP Guard Cartridges—for All Raptor Columns

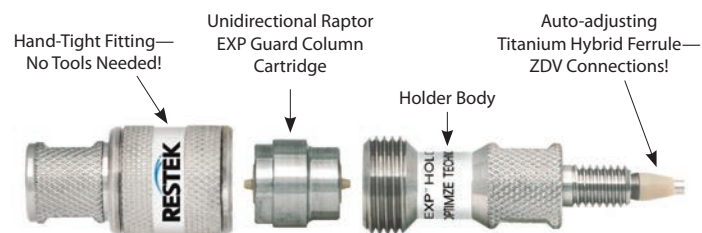

Protect your investment, extend the life of our already-rugged LC columns, and change guard column cartridges by hand without breaking fluid connections—no tools needed! Great with any Raptor column to get ultimate protection from particulates and matrix contamination, especially when using dilute-and-shoot or other minimal sample preparation techniques.

EXP Direct Connect Holder

Description	qty.	cat.#
EXP Direct Connect Holder for EXP Guard Cartridges (includes hex-head fitting & 2 ferrules)	ea.	25808

Maximum holder pressure: 20,000 psi (1,400 bar)

Raptor EXP Guard Column Cartridges

Description	Particle Size	qty.	5 x 2.1 mm cat.#	5 x 3.0 mm cat.#	5 x 4.6 mm cat.#
Raptor C18 EXP Guard Column Cartridge	UHPLC	3-pk.	9304U0252	9304U0253	
Raptor C18 EXP Guard Column Cartridge	2.7 µm	3-pk.	9304A0252	9304A0253	9304A0250
Raptor C18 EXP Guard Column Cartridge	5 µm	3-pk.	930450252	930450253	930450250

1,034 bar/15,000 psi* (UHPLC), 600 bar/8,700 psi (2.7 µm); 400 bar/5,800 psi (5 µm).

* For maximum lifetime, recommended maximum pressure for 1.8 µm particles is 830 bar/12,000 psi.

Raptor SPP LC columns combine the speed of SPP with the resolution of USLC technology. Learn more at www.restek.com/raptor

UltraShield UHPLC PreColumn Filter—for 1.8 µm Raptor Columns

Pair 1.8 µm Raptor columns with an UltraShield filter instead of a guard cartridge to protect against particulates, minimize extra column volume, and maximize UHPLC sample throughput when using SPE, SLE, or other extensive sample preparations.

Description	Filter Porosity	qty.	cat.#
UltraShield UHPLC PreColumn Filter	0.2 µm frit	ea.	25809
		5-pk.	25810
		10-pk.	25811



The Raptor HILIC-Si Column—Simplify the Switch to HILIC

With Raptor LC columns, Restek chemists became the first to combine the speed of superficially porous particles (also known as SPP or “core-shell” particles) with the resolution of highly selective USLC technology. This new breed of chromatographic column allows you to more easily achieve peak separation and faster analysis times without expensive UHPLC instrumentation. Restek is extending the speed and reliability of Raptor to the HILIC realm with the addition of the Raptor HILIC-Si column.

Hydrophilic-interaction chromatography (HILIC) (1) is an increasingly popular alternative to reversed-phase LC for challenging polar analytes because it provides better retention of water-soluble compounds that are separated by polar differences (Figure 20). The Raptor HILIC-Si column simplifies the switch to HILIC because it delivers rugged Raptor performance, provides SPP column speed for faster analyses than traditional FPP silica columns, retains polar compounds without ion-pairing reagents, and is fully reliable, efficient, and selective with LC-MS compatible mobile phases.

Order yours today at www.restek.com/raptor

Figure 20: Use HILIC when greater retention of polar analytes is needed. In HILIC mode, the aqueous mobile phase is the strong (or eluting) solvent versus the more familiar reversed-phase mode, where elution is the result of the organic solvent strength.

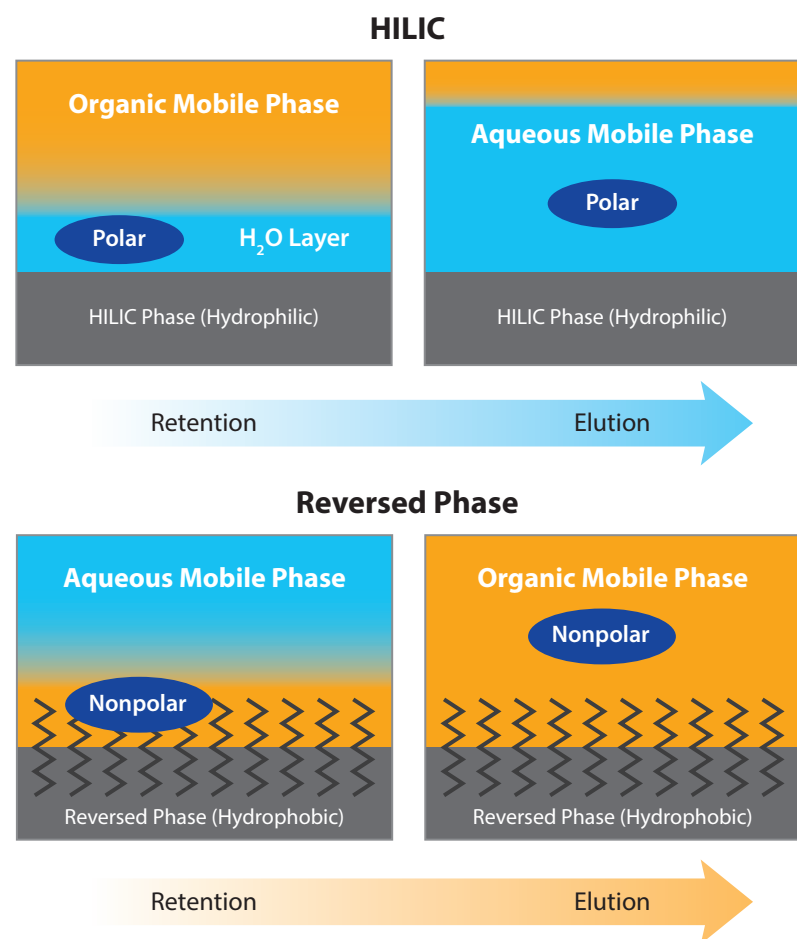

Column Description:



Pore Size:

90 Å

Particle:

2.7 µm superficially porous silica (SPP or “core-shell”)

Surface Area:

130 m²/g

End-Cap:

No

Carbon Load:

NA

USP Phase Code:

L3

Phase Category:

Bare silica

Ligand Type:

None

Recommended Usage:

pH Range: 2.0–8.0

Maximum Temperature: 80 °C

Maximum Pressure: 600 bar/8,700 psi

Properties:

- Compatible with both HPLC and UHPLC instruments.
- Restek’s 2.7 µm core-shell particles provide Raptor performance and the speed of SPP.

Switch to a Raptor HILIC-Si LC column when:

- Increased retention of small polar compounds is needed.
- You want to avoid using ion-pairing reagents.
- You want retention and sensitivity for hydrophilic compounds by LC-MS.



(1) A.J. Alpert, Hydrophilic-interaction chromatography for the separation of peptides, nucleic acids and other polar compounds, J. Chromatogr. 499 (1990) 177–196.

Raptor Technology Ensures Rugged, Reproducible Performance in the HILIC Realm

Raptor LC columns are well known for their rugged dependability, and the new Raptor HILIC-Si column brings the consistency of Raptor performance to HILIC. Lot to lot, column to column, and injection to injection, every Raptor HILIC-Si column gives a consistent performance that you can count on (Figures 21 and 22). Simplify your move to HILIC with the reliability of Raptor HILIC-Si columns.

Figure 21: Raptor HILIC-Si columns maintain efficiency at any dimension, even at operating pressures up to 575 bar so you can run at high linear velocities with confidence.

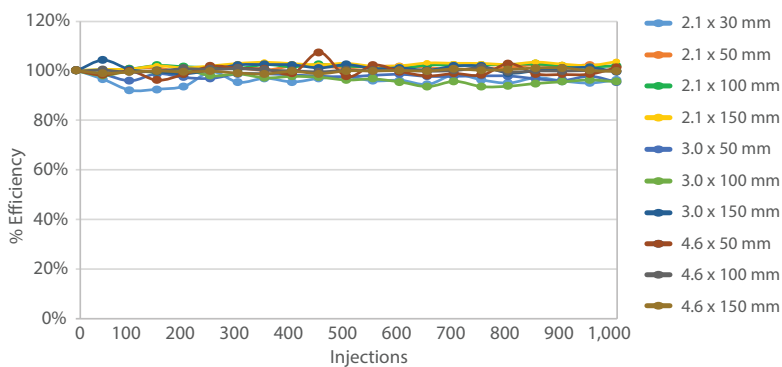

All testing performed using 2.7 μm Raptor HILIC-Si columns.

Figure 22: Strict quality control guarantees that rugged Raptor HILIC-Si columns provide reproducible results lot after lot and injection after injection.

Peaks	Conc. (ng/mL)	Precursor Ion	Product Ion	Product Ion
1. 3-Methoxytyramine	1	151.00	119.00	91.02
2. Metanephrine	1	179.94	148.22	165.01
3. Normetanephrine	1	166.00	134.02	121.01

Peaks	Conc. (ng/mL)	Precursor Ion	Product Ion	Product Ion	1st Injection (tr)	135th Injection (tr)
1. 3-Methoxytyramine	1	151.00	119.00	91.02	1.80	1.83
2. Metanephrine	1	179.94	148.22	165.01	2.03	2.07
3. Normetanephrine	1	166.00	134.02	121.01	2.11	2.15

Consistent Performance across Lots

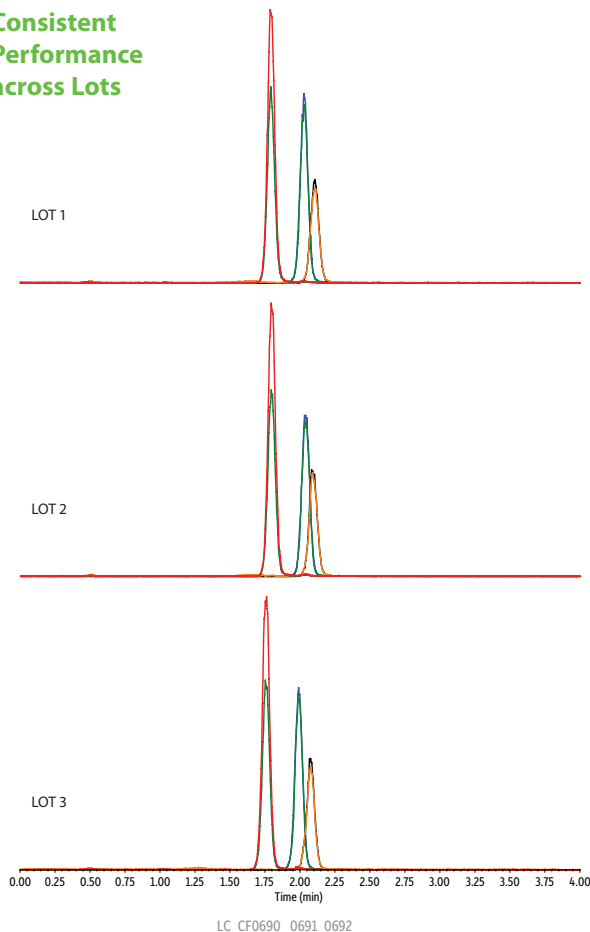

Stable Results Injection after Injection

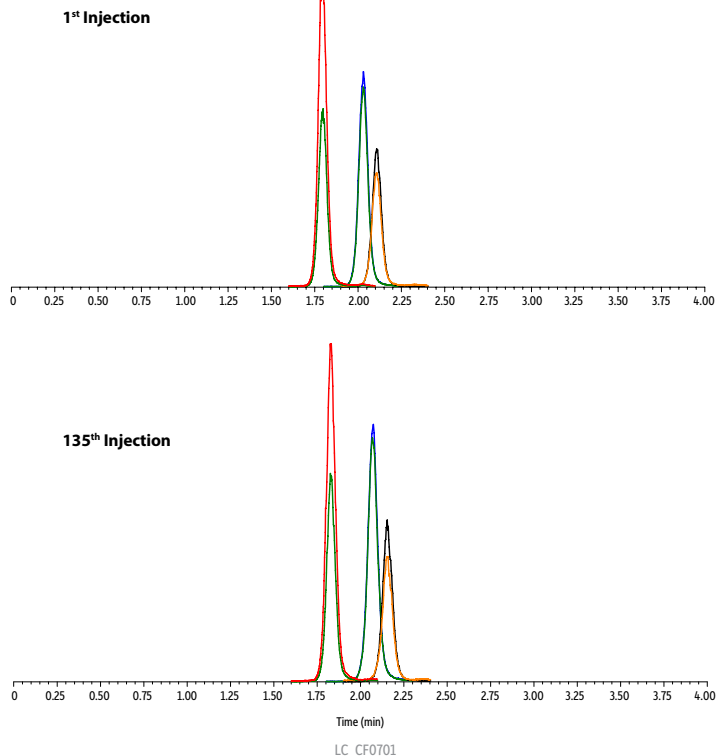

Column: Raptor HILIC-Si (cat.# 9310A52); Dimensions: 50 mm x 2.1 mm ID, Particle Size: 2.7 μm; Temp.: 30 °C; Sample: Diluent: Mobile phase A:mobile phase B (10:90); Conc.: 1 ng/mL; Inj. Vol.: 10 μL; Mobile Phase: A: Water, 100 mM ammonium formate, pH 3.0; B: Acetonitrile; Gradient (%B): 0.00 min (90% B), 5.00 (90% B); Flow: 0.3 mL/min; Detector: MS/MS; Ion Mode: ESI+; Mode: MRM; Instrument: UHPLC

Raptor SPP + HILIC = More Speed, More Sensitivity

What makes Raptor HILIC-Si columns special? The answer is simple: you get the speed of a Raptor SPP column with the unique separating power of the HILIC retention mechanism. The benefits of superficially porous particles (SPP) are well known. SPP columns are characterized by a layer of porous silica bonded to a solid silica core, which gives faster, more efficient analyses. As shown in Figure 23, when you keep instrument parameters constant (flow, gradient, temperature) and compare a 3 μm fully porous particle (FPP) silica column to a 2.7 μm Raptor HILIC-Si SPP column, the benefits become clear. Raptor HILIC-Si columns combine faster analysis times with higher sensitivity so you can increase sample throughput and lower limits of quantification (LOQs) for difficult-to-retain polar analytes.

Figure 23: Raptor HILIC-Si columns provide the speed of SPP so you can analyze more samples per day.

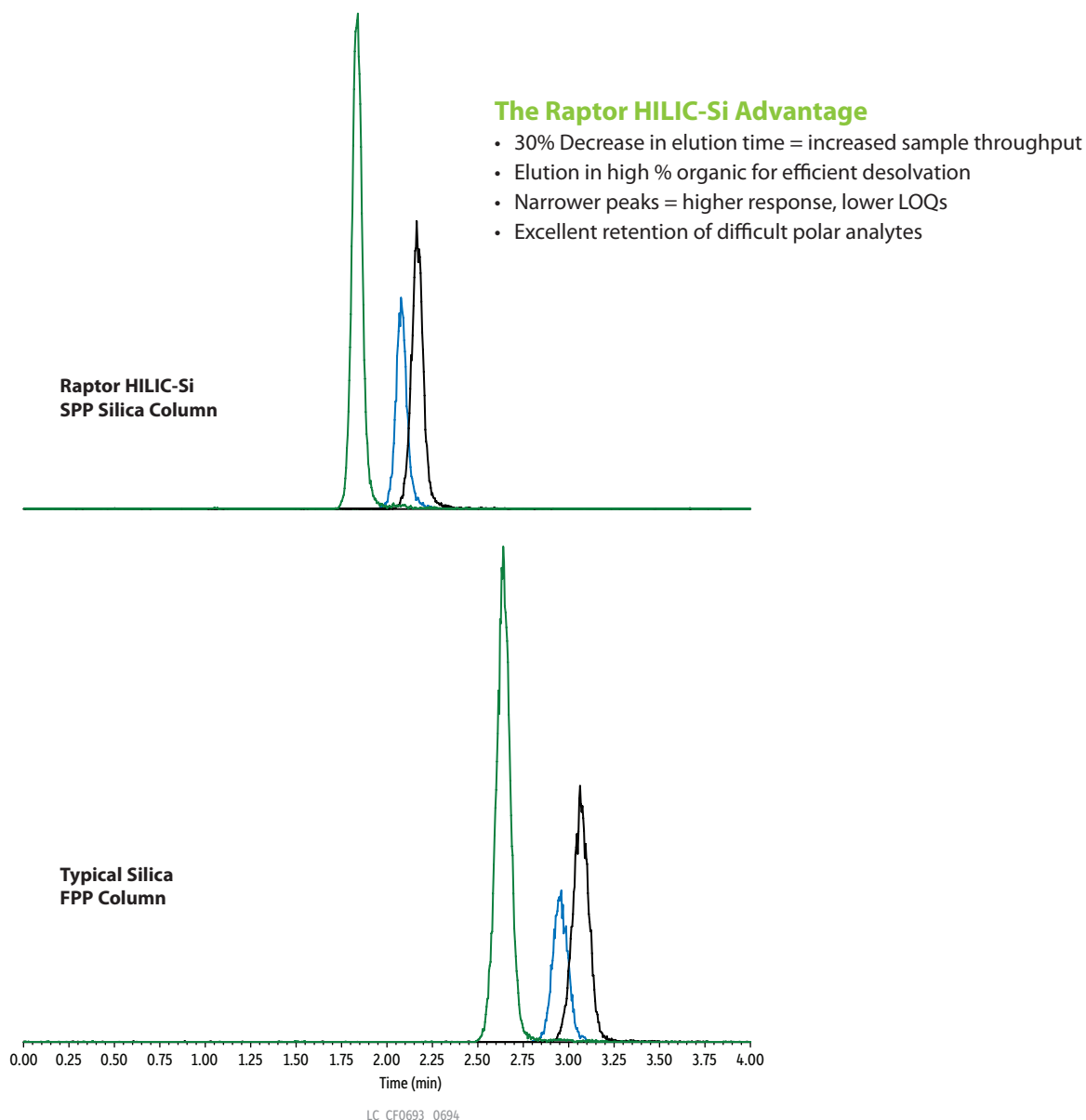

Peaks	Conc. (ng/mL)	Precursor Ion	Product Ion	Raptor t_R (min)	Typical t_R (min)
1. 3-Methoxytyramine	1	151.00	119.00	1.84	2.64
2. Metanephine	1	179.94	148.22	2.08	2.96
3. Normetanephine	1	166.00	134.02	2.16	3.06

Raptor HILIC-Si SPP column (cat.# 9310A52) 50 mm x 2.1 mm ID, Particle Size: 2.7 μm ; Typical silica FPP column, 50 mm x 2.1 mm ID, Particle Size: 3.0 μm ; Temp.: 30 $^{\circ}\text{C}$; Sample: Diluent: Mobile phase A: mobile phase B (10:90); Conc.: 1 ng/mL; Inj. Vol.: 10 μL ; Mobile Phase: A: Water, 100 mM ammonium formate, pH 3.0; B: Acetonitrile; Gradient (%B): 0.00 min (90% B), 5.00 (90% B); Flow: 0.3 mL/min; Detector: MS/MS; Ion Mode: ESI+; Mode: MRM; Instrument: UHPLC

Raptor HILIC-Si Performance Gains vs. RP: Say Good-bye to Ion-Pairing Reagents

HILIC methods are becoming more common as analysts search for better solutions to challenging reversed-phase (RP) analyses. But, when is HILIC a beneficial alternative to a standard RP approach? HILIC should be considered when analyzing small polar compounds that are difficult to retain in RP mode without the use of ion-pairing reagents in the mobile phase. For example, paraquat and diquat are highly charged quaternary amine herbicides that are often analyzed in RP mode using ion-pairing reagents (Figure 24). But, these reagents can contaminate your LC-MS/MS and require the system be taken off-line frequently for extensive cleaning. With Raptor HILIC-Si columns, ion-pairing reagents are not needed and paraquat and diquat are quickly retained and resolved with MS-friendly solvents and buffers so your instrument stays up and running longer (Figure 25).

Figure 24: RP Analysis of Paraquat and Diquat with Ion-Pairing Mobile Phase Reagent

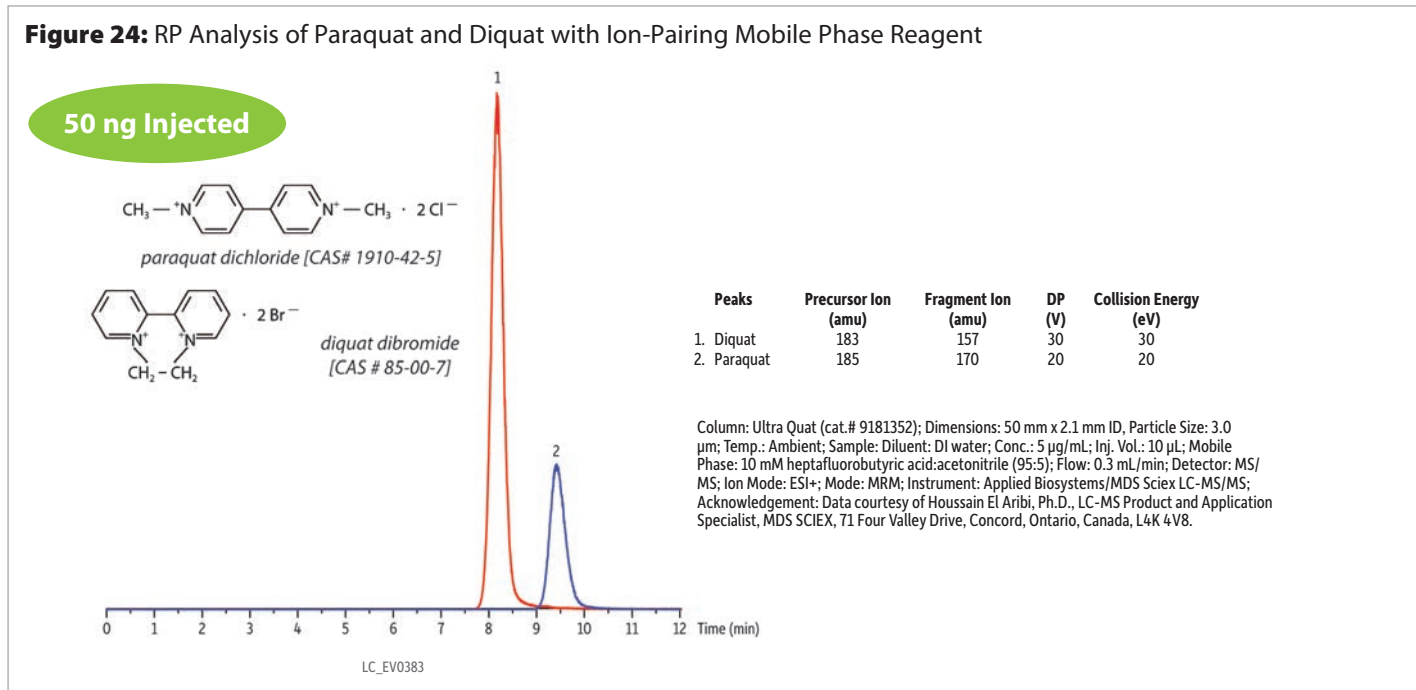
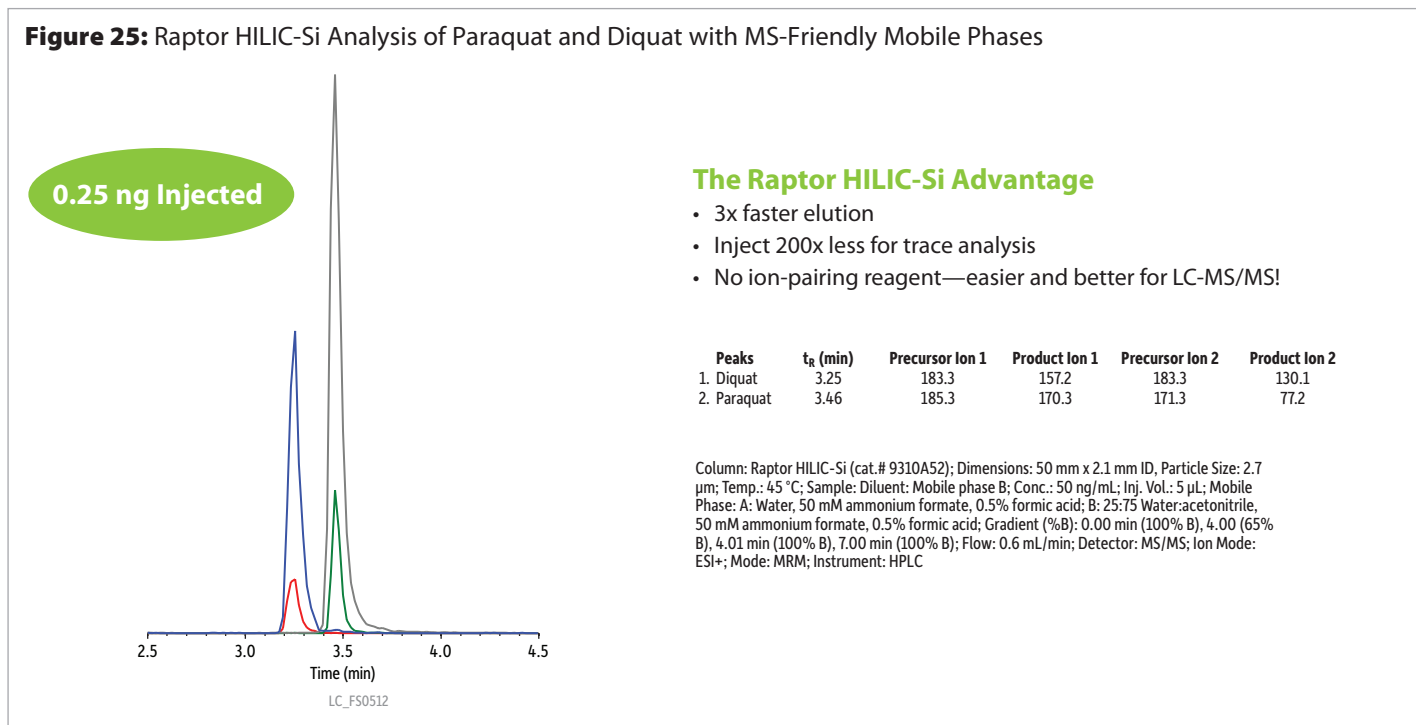

Figure 25: Raptor HILIC-Si Analysis of Paraquat and Diquat with MS-Friendly Mobile Phases



Raptor HILIC-Si Improves the Performance of Your LC-MS/MS

One of the most striking ways that HILIC analyses differ from standard RP analyses is that in HILIC methods the aqueous mobile phase is the stronger solvent. It provides differential selectivity that helps retain small polar analytes until after the sample matrix has eluted. In addition, the higher concentration organic mobile phases used in HILIC methods improve solvent evaporation during electrospray ionization, leading to increased sensitivity for LC-MS/MS methods. The following applications illustrate the decrease in matrix interference and increase in LC-MS/MS sensitivity that can be obtained using HILIC conditions and a Raptor HILIC-Si column.

Monoamine Neurotransmitters and Metabolites

Measurements of monoamine neurotransmitters and their metabolites in plasma and urine are commonly used for clinical diagnosis and monitoring of neuroblastoma and pheochromocytoma. Quantifying free metanephrine and normetanephrine is the most sensitive and accurate test for this purpose, but analysis of these polar compounds using reversed-phase LC is problematic due to very limited retention and poor sensitivity. As shown in Figure 26, these polar metabolites can be adequately retained on a Raptor HILIC-Si column and detected at 50 pg/mL in human plasma, providing the sensitivity needed for clinical purposes (Figure 26).

Figure 26: Trace-Level Metanephrine, Normetanephrine, and 3-Methoxytyramine in Human Plasma

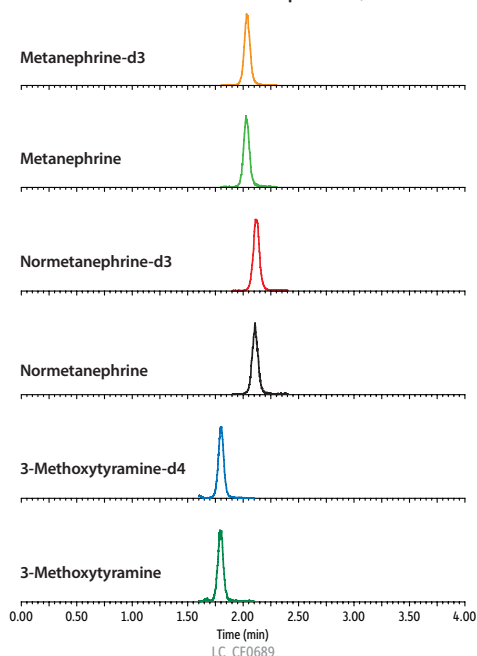

Even at 50 pg/mL, good signal-to-noise ratios mean lower LOQs and accurate results at trace levels.

Peaks	t _R (min)	Conc. (pg/mL)	Precursor Ion	Product Ion
1. 3-Methoxytyramine-d4 (IS)	1.80	400	155.07	122.93
2. 3-Methoxytyramine	1.80	50	151.00	119.00
3. Metanephrine-d3 (IS)	2.03	200	183.00	151.15
4. Metanephrine	2.03	50	179.94	148.22
5. Normetanephrine-d3 (IS)	2.11	400	169.00	136.96
6. Normetanephrine	2.11	50	166.00	134.02

Column: Raptor HILIC-Si (cat. # 9310A52); Dimensions: 50 mm x 2.1 mm ID, Particle Size: 2.7 µm; Temp.: 30 °C; Sample: Diluent: Mobile phase A: mobile phase B (10:90); Inj. Vol.: 10 µL; Mobile Phase: A: Water, 100 mM ammonium formate, pH 3.0; B: Acetonitrile; Gradient (%B): 0.00 min (90% B), 5.00 min (90% B); Flow: 0.3 mL/min; Detector: MS/MS; Ion Mode: ESI+; Mode: MRM; Instrument: UHPLC; Notes: For sample preparation details, enter chromatogram LC_CF0689 in the www.restek.com search.

Food Adulterants

Foods that contain a high protein content command a higher price, which can result in the illegal practice of food adulteration using nitrogen-rich compounds, such as melamine, to make the protein content appear higher than the actual value. Due to its potential for toxicity, testing for melamine and other structurally related compounds is required in many countries for foods, feed materials, and pharmaceutical components. The method shown in Figure 27 provides excellent retention of these highly polar analytes with a separation time of only 3.5 minutes and a complete cycle time of just 8 minutes using a Raptor HILIC-Si column.

Figure 27: Food Adulterants on Raptor HILIC-Si

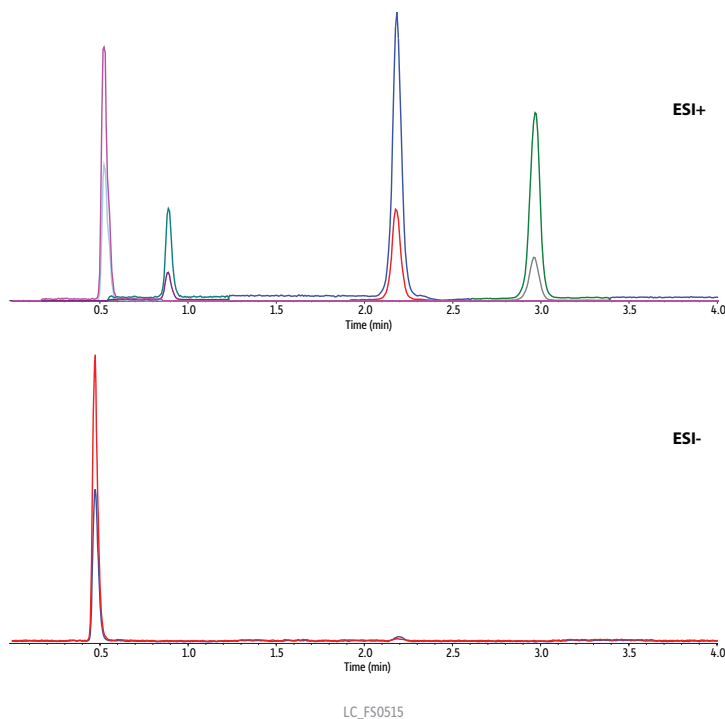

The Raptor HILIC-Si column simplifies the analysis of difficult-to-retain polar analytes, such as melamine and related compounds.

Peaks	t _R (min)	Precursor Ion	Product Ion	Product Ion	Polarity
1. Cyanuric acid	0.47	127.8	84.9	42.1	-
2. Cyromazine	0.52	167.0	68.2	85.1	+
3. Melamine	0.89	127.2	85.0	68.3	+
4. Ammelide	2.18	129.1	86.1	70.2	+
5. Ammeline	2.97	128.2	86.2	69.1	+

Column: Raptor HILIC-Si (cat.# 9310A52); Dimensions: 50 mm x 2.1 mm ID, Particle Size: 2.7 µm; Temp.: 30 °C; Sample: Diluent: 5:95 Water:acetonitrile, 10 mM ammonium formate, 0.1% formic acid; Conc.: 25 ng/mL; Inj. Vol.: 5 µL; Mobile Phase: A: Water, 10 mM ammonium formate, 0.1% formic acid; B: 5:95 Water:acetonitrile, 10 mM ammonium formate, 0.1% formic acid; Gradient (%B): 0.00 min (100% B), 0.50 (100% B), 3.50 min (95% B), 3.51 min (100% B), 8.00 min (100% B); Flow: 0.6 mL/min; Detector: MS/MS; Ion Mode: ESI+/ESI-; Mode: Scheduled MRM; Instrument: HPLC

Have More Questions about HILIC?

Our online frequently asked questions (FAQs) cover many common topics we cover in Technical Service on a regular basis! Get your answers at

www.restek.com/HILIC-FAQ

Raptor HILIC-Si: Simplify the Switch to HILIC

Where's my 5 µm column?

Because HILIC methods use highly organic mobile phases, they generate very low backpressures. We've simplified your move to HILIC by offering the Raptor HILIC-Si column in a 2.7 µm particle size only. Our testing and applications development demonstrated that 2.7 µm columns offer higher efficiency than 5 µm columns, and they are compatible with any HPLC or UHPLC instrument you have in your lab.

Raptor HILIC-Si LC Columns (USP L3)



Length	2.1 mm cat.#	3.0 mm cat.#	4.6 mm cat.#
2.7 µm Columns			
30 mm	9310A32		
50 mm	9310A52	9310A5E	9310A55
100 mm	9310A12	9310A1E	9310A15
150 mm	9310A62	9310A6E	9310A65

Raptor EXP Guard Cartridges

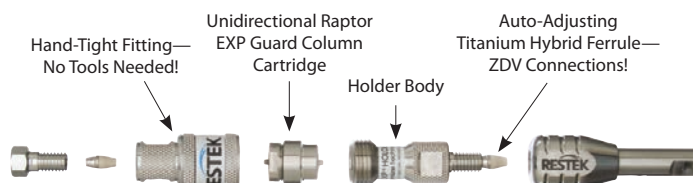

Protect your investment and extend the life of our already-rugged LC columns and change guard column cartridges by hand without breaking fluid connections—no tools needed!

EXP Direct Connect Holder

Description	qty.	cat.#
EXP Direct Connect Holder for EXP Guard Cartridges (includes hex-head fitting & 2 ferrules)	ea.	25808

Maximum holder pressure: 20,000 psi (1,400 bar)

Raptor EXP Guard Column Cartridges

Description	Particle Size	qty.	5 x 2.1 mm	5 x 3.0 mm	5 x 4.6 mm
			cat.#	cat.#	cat.#
Raptor HILIC-Si EXP Guard Column Cartridge	2.7 µm	3-pk.	9310A0252	9310A0253	9310A0250

Maximum cartridge pressure: 600 bar/8,700 psi (2.7 µm) or 400 bar/5,800 psi (5 µm).
Raptor SPP LC columns combine the speed of SPP with the resolution of USLC technology. Learn more at www.restek.com/raptor

Experience *Selectivity Accelerated*. Order the Raptor HILIC-Si today at www.restek.com/raptor

The Raptor EtG/EtS Column— All Matrix Interferences Resolved

- Proven performance for accurate, reliable ethyl glucuronide (EtG) and ethyl sulfate (EtS) analysis.
- Strong retention consistently resolves analytes from matrix interferences.
- Long column lifetime ensures consistent performance injection after injection.
- Fast, 4-minute, dilute-and-shoot LC-MS/MS analysis supports high sample throughput.

Switch to a Raptor EtG/EtS column when you need consistent resolution of EtG and EtS from matrix interferences and long column lifetimes.

Order yours today at www.restek.com/raptor

Column Description:

**Pore Size:**

90 Å

Particle:

2.7 µm superficially porous silica (SPP or "core-shell")

Surface Area:

130 m²/g

End-Cap:

Proprietary

Carbon Load:

Proprietary

USP Phase Code:

NA

Phase Category:

Proprietary

Ligand Type:

Proprietary

Recommended Usage:

pH Range: 2.0–8.0

Maximum Temperature: 80 °C

Maximum Pressure: 600 bar/8,700 psi

Properties:

- Resolution of EtG and EtS from matrix interferences.
- Increased retention of EtG and EtS compared to traditional phases.

Switch to a Raptor EtG/EtS when:

- Other columns can't resolve EtG and EtS from matrix components.
- You need high-throughput EtG/EtS analysis.
- Low-level detection limits are desired.



Definitive Results for Alcohol Monitoring

Restek has developed a new Raptor column that significantly improves EtG and EtS analysis for alcohol monitoring programs. The Raptor EtG/EtS column consistently retains and resolves these important biomarkers from matrix interferences, providing accurate, reliable results injection after injection (Figure 28). Dependable performance, a fast 4-minute analysis, and long column lifetime make this column ideal for high-throughput labs. Paired with our quality reference standards and the optimized, validated method shown below, Restek's Raptor EtG/EtS column is part of a complete solution that will help testing labs save time and increase certainty.

Figure 28: Rugged Raptor EtG/EtS columns provide complete resolution and consistent results even after 1,000 injections, allowing more samples to be analyzed between column changes.

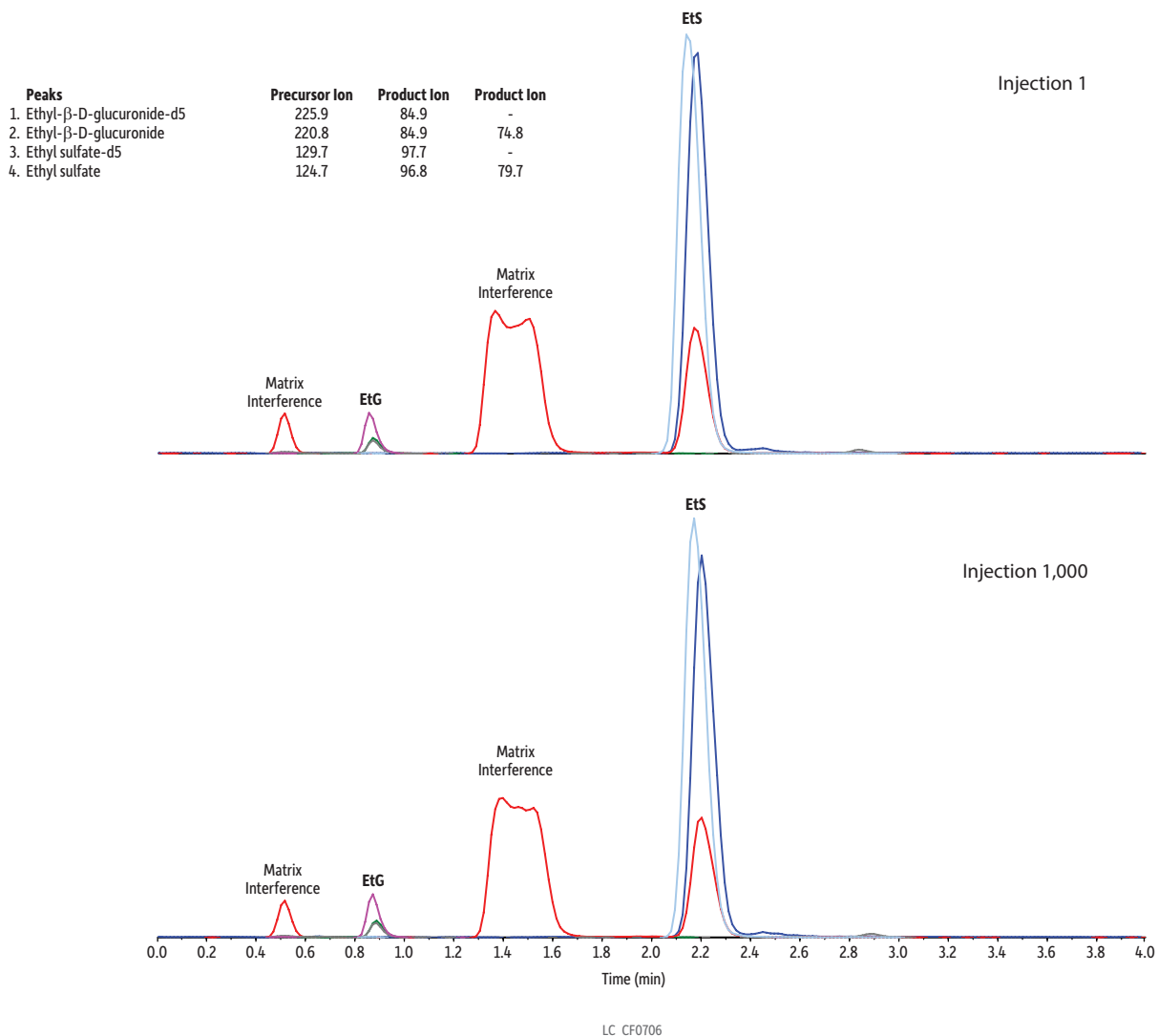

Column: Raptor EtG/EtS (cat.# 9325A12); Dimensions: 100 mm x 2.1 mm ID, Particle Size: 2.7 μm; Guard Column: UltraShield UHPLC precolumn filter, 0.2 μm frit (cat.# 25809); Temp.: 35 °C; Sample: A 500 ng/mL QC sample was prepared in urine. 50 μL of the sample was diluted with 950 μL of a working internal standard (25 ng/mL EtS-d5/100 ng/mL EtG-d5 in 0.1% formic acid in water). The sample was vortexed at 3,500 rpm for 10 seconds to mix. The sample was then centrifuged at 3,000 rpm for 5 minutes at 10 °C. The autosampler needle was adjusted to inject from the supernatant. Inj. Vol.: 10 μL; Mobile Phase: A: 0.1% Formic acid in water; B: 0.1% Formic acid in acetonitrile; Gradient (%B): 0.00 min (5% B), 2.50 min (35% B), 2.51 min (5% B), 4.00 (5% B); Flow: 0.5 mL/min; Detector: MS/MS; Ion Mode: ESI-; Mode: MRM; Instrument: HPLC; Notes: The following reference standards were used: ethyl-β-D-glucuronide (cat.# 34101), ethyl-β-D-glucuronide-d5 (cat.# 34102), ethyl sulfate sodium salt (cat.# 34103), ethyl sulfate-d5 sodium salt (cat.# 34104).

Struggling with EtG/EtS matrix interferences? Here's your solution!

Raptor EtG/EtS LC Column



- Proven performance for accurate, reliable ethyl glucuronide (EtG) and ethyl sulfate (EtS) analysis.
- Strong retention consistently resolves analytes from matrix interferences.
- Long column lifetime ensures consistent performance injection after injection.
- Fast, 4-minute, dilute-and-shoot LC-MS/MS analysis supports high sample throughput.
- Save time and increase certainty with Restek's definitive EtG/EtS method and quality reference standards.

Length	2.1 mm cat.#
2.7 µm Column	
100 mm	9325A12

Did you know consistent EtG/EtS results depend on proper column conditioning?
Learn how to ensure stable performance at www.restek.com/EtGtip

UltraShield UHPLC PreColumn Filter

- Cost-effective protection for UHPLC systems.
- Reliable way to extend column lifetime.
- Universal fit—connects easily to any brand column.
- Leak tight to 15,000 psi (1,034 bar).
- 0.5 µm or 0.2 µm stainless steel frit in a stainless steel body with PEEK ferrule.



Description	Filter Porosity	qty.	cat.#
UltraShield UHPLC PreColumn Filter	0.5 µm frit	ea.	24995
		5-pk.	24996
		10-pk.	24997
UltraShield UHPLC PreColumn Filter	0.2 µm frit	ea.	25809
		5-pk.	25810
		10-pk.	25811

Experience *Selectivity Accelerated*. Order the Raptor EtG/EtS today at www.restek.com/raptor

EtG and EtS Standards

- Alcohol metabolite biomarkers for monitoring alcohol consumption in urine samples.
- Available as unlabeled standards for instrument calibration and as deuterated internal standards for sample analysis.
- Verified composition and stability.
- Pair with Restek's definitive EtG/EtS method, and Raptor EtG/EtS LC column for accurate, reliable results.
- Certified reference materials (CRMs) manufactured and QC tested in ISO-accredited labs satisfy your ISO requirements.



Ethyl-β-D-glucuronide (EtG)

Ethyl-β-D-glucuronide (EtG) (17685-04-0)
1,000 µg/mL in methanol, 1 mL/ampul cat.# 34101 (ea.)

Ethyl-β-D-glucuronide-d5 (EtG-d5)

Ethyl-β-D-glucuronide-d5 (EtG-d5) (1135070-98-2)
1,000 µg/mL in methanol, 1 mL/ampul cat.# 34102 (ea.)

Ethyl sulfate sodium salt (EtS)

Ethyl sulfate sodium salt (EtS) (546-74-7)
1,000 µg/mL in methanol, 1 mL/ampul cat.# 34103 (ea.)

Ethyl sulfate-d5 sodium salt (EtS-d5)

Ethyl sulfate-d5 sodium salt (EtS-d5) (1329611-05-3)
1,000 µg/mL in methanol, 1 mL/ampul cat.# 34104 (ea.)

Notes:



- Long-lasting and reproducible.
- Fully scalable between HPLC and UHPLC.
- Premium quality with 100% Pure Satisfaction guarantee.

www.restek.com/force



Force Performance LC Columns— Apply Force to Your LC Methods

Restek's new Force performance LC columns give you the power to maximize instrument uptime, increase productivity, and transfer methods across your entire lab, from your trusted-but-aged HPLC to the cutting-edge UHPLC you just plumbed last week. This incredibly rugged and supremely consistent column line represents the culmination of our twenty-plus years in LC dedicated to continually improving our phase chemistries, our lot and lifetime testing, and our bonding and packing procedures.

- Long-lasting and reproducible—maintain stable retention times and peak shapes, even under the stress of elevated UHPLC pressures and rapid cycling.
- Fully scalable between 3 or 5 μm HPLC and 1.8 μm UHPLC—easily transfer and optimize methods without extensive calculations.
- Premium quality ensured by strict manufacturing and QC procedures—backed by the strength of our 100% Pure Satisfaction guarantee.

Meet today's workflow needs—and prepare for tomorrow's—by applying Force LC columns to all of your instrument platforms. Order yours today at www.restek.com/force

Available with Restek's most-popular and highly selective Biphenyl and FluoroPhenyl phases, as well as a general-purpose C18.

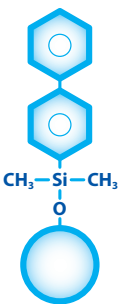
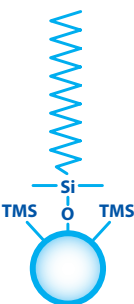
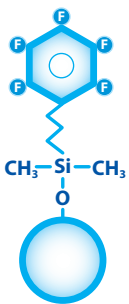
	Biphenyl	C18	FluoroPhenyl
			
USP Phase Code	L11	L1	L43
Stationary Phase Category	Phenyl	C18, octadecylsilane	Pentafluorophenyl propyl
Ligand Type	Biphenyl	End-capped C18	Fluorophenyl
Particle Size	1.8 μm , 3 μm , or 5 μm fully porous	1.8 μm , 3 μm , or 5 μm fully porous	1.8 μm , 3 μm , or 5 μm fully porous
Pore Size	100 Å	100 Å	100 Å
Surface Area	300 m^2/g	300 m^2/g	300 m^2/g
Carbon Load	15%	20%	10%
End-Cap	yes	yes	no
pH Range	2.0 to 8.0	2.0 to 8.0	2.0 to 8.0
Maximum Temperature	80 °C	80 °C	80 °C

Apply Force to Your LC Methods...

... for Longer Column Life

Elevated pressures and rapid pressure cycling put extreme stress on your LC column and shorten its life. And, when the demand to increase lab productivity meets the growing pressure limits of modern LCs and the faster cycle times of new methods, many competitor columns simply can't survive. Force LC columns from Restek are designed and manufactured to handle high-pressure, high-stress conditions. Whether you're running a 3 or 5 μm column on an older HPLC or a 1.8 μm on the newest UHPLC in your lab (Figures 29 and 30), your method will give you the same separation from one injection to the next when you trust your workflow to the extended lifetime of a Force LC column.

Figure 29: At over 10,000 psi, you may be used to seeing a drop in efficiency, but Force LC columns will take the pressure.

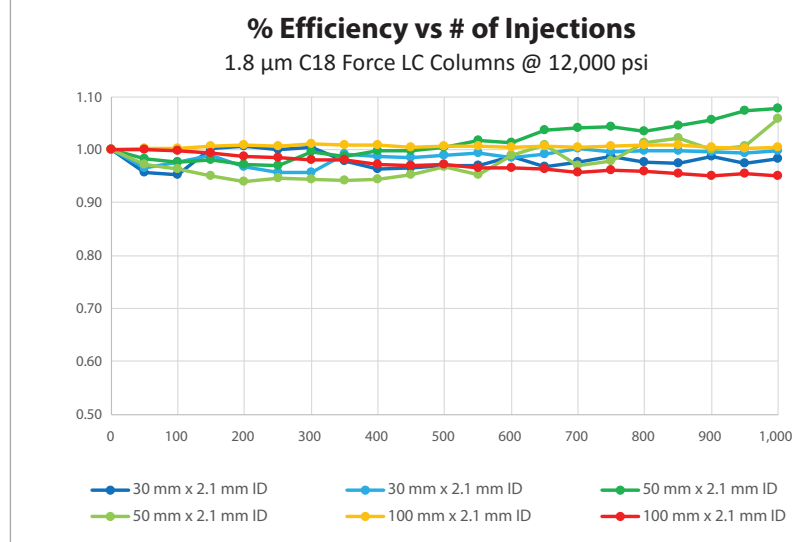
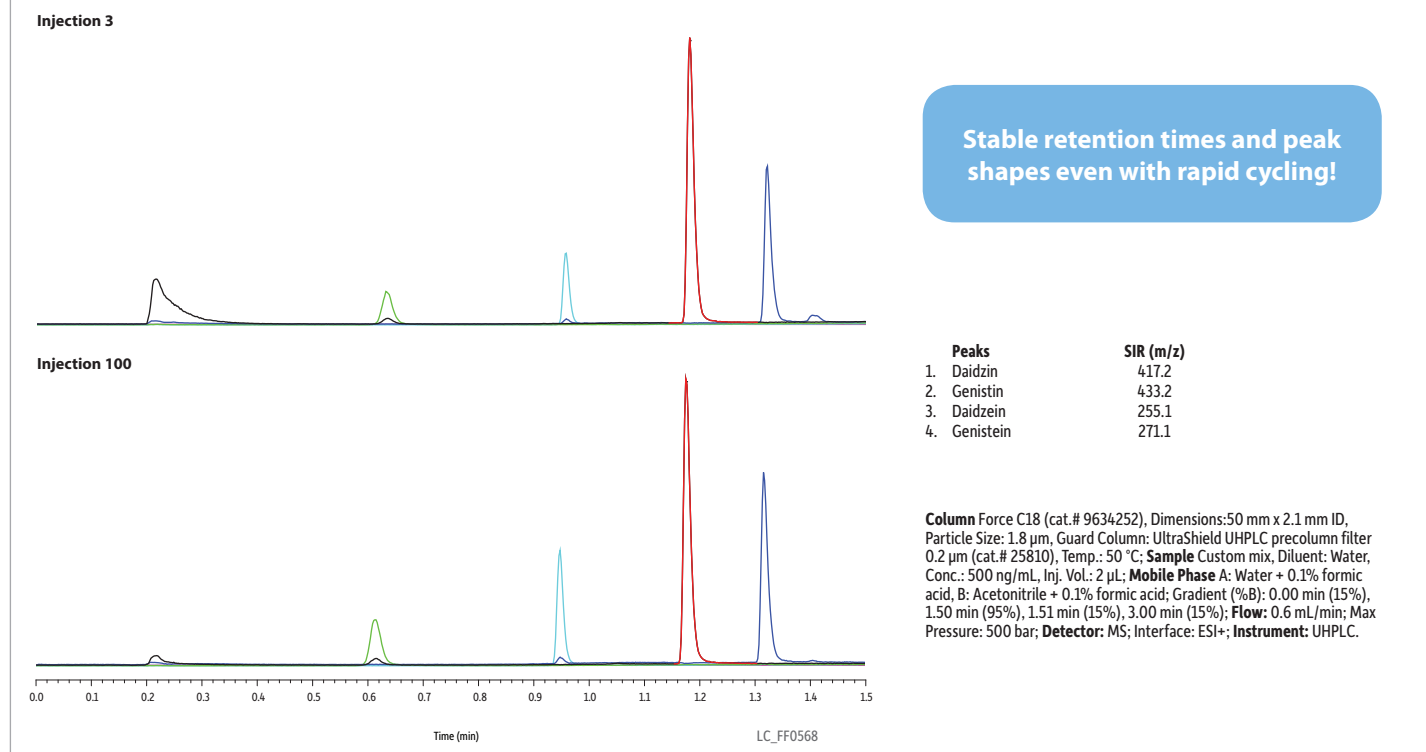

Figure 30: Rapid changes in pressure place more stress on a column than even high pressures can, but Force LC columns will handle repeated analyses with no change in separation.



... for Improved Reproducibility

Once you set up and validate a workflow, you move on to developing the next new method. You don't have time to repeatedly revisit past methods because your chosen column is giving you different results with each lot. Peak shapes and retention times need to be maintained over the lifetime of your workflow to ensure consistent results, reduce unplanned downtime, and preserve your own productivity. Force LC columns have the lot-to-lot reproducibility you need to rely on (Figure 31)—backed by Restek's strict QC system and our 100% Pure Satisfaction guarantee—so that you are free to focus your energy on what's next.

Figure 31: Whether a standard C18 or our FluoroPhenyl with its innovative new bonding process, each subsequent Force column you order will give you the same outstanding performance as the first.

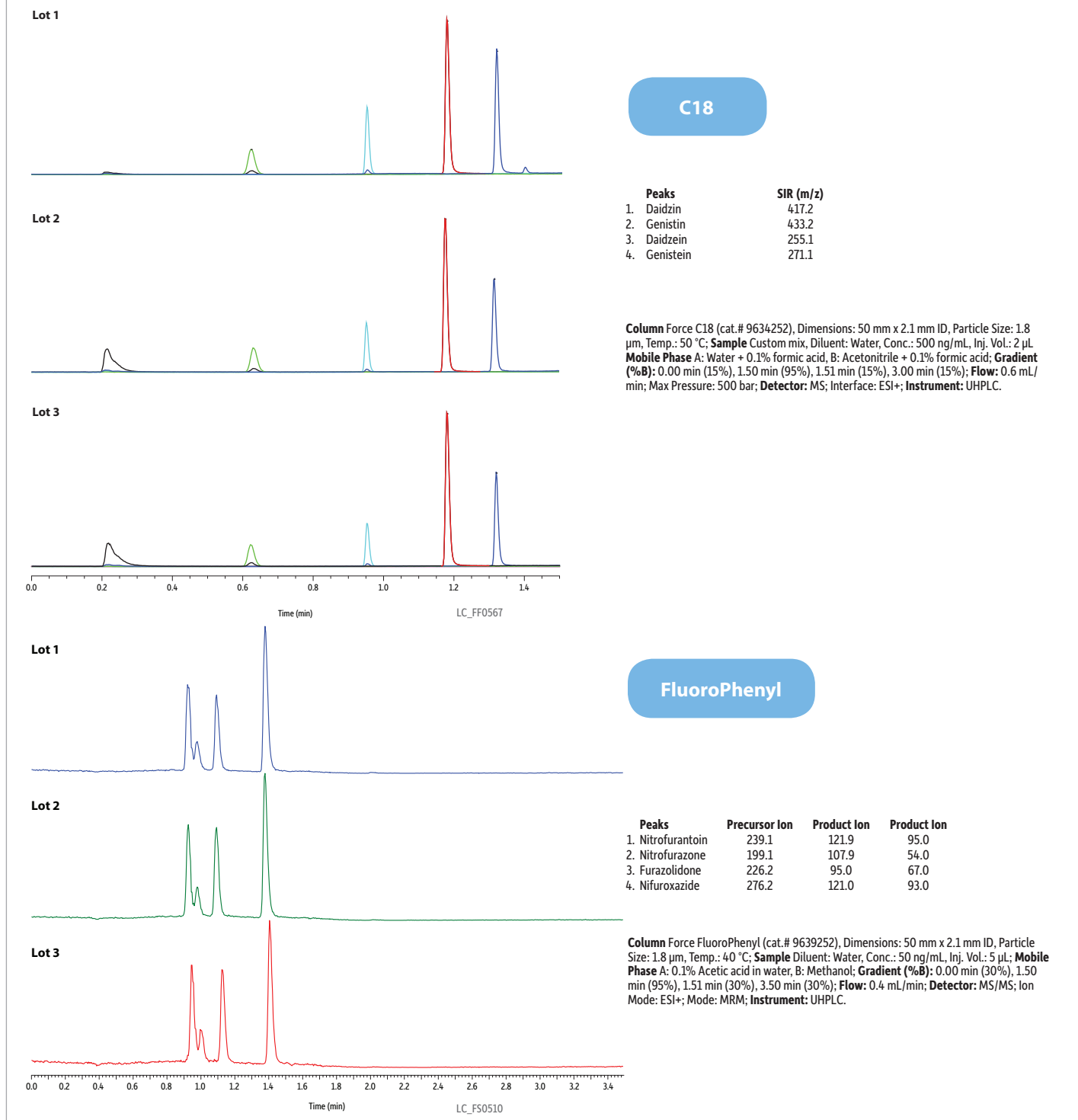

... for Complete Scalability

To accelerate time to market, analysts will often develop methods on fast UHPLC instruments using sub-2 μm particle columns. But, the methods must then be scaled to match the analysis time and pressure limitations of the traditional HPLCs and the 3 or 5 μm columns that will actually be doing the work. To make this transition easier and ensure consistent results, Force LC columns are available in three particle sizes that are manufactured on the same silica support with the same properties to reliably and easily provide the same separation on any instrument platform (Figure 32).

And, of course, it works both ways: fully scalable Force LC columns also make it easy to update conventional HPLC methods to UHPLC instruments to increase sample throughput and reduce solvent consumption and waste disposal costs.

Figure 32: With identical isocratic flow rates, 5, 3, and 1.8 μm Force columns still offer the same results. (If using a gradient, simple equations can help you adjust slope and time points.) Scaling doesn't get easier than that!

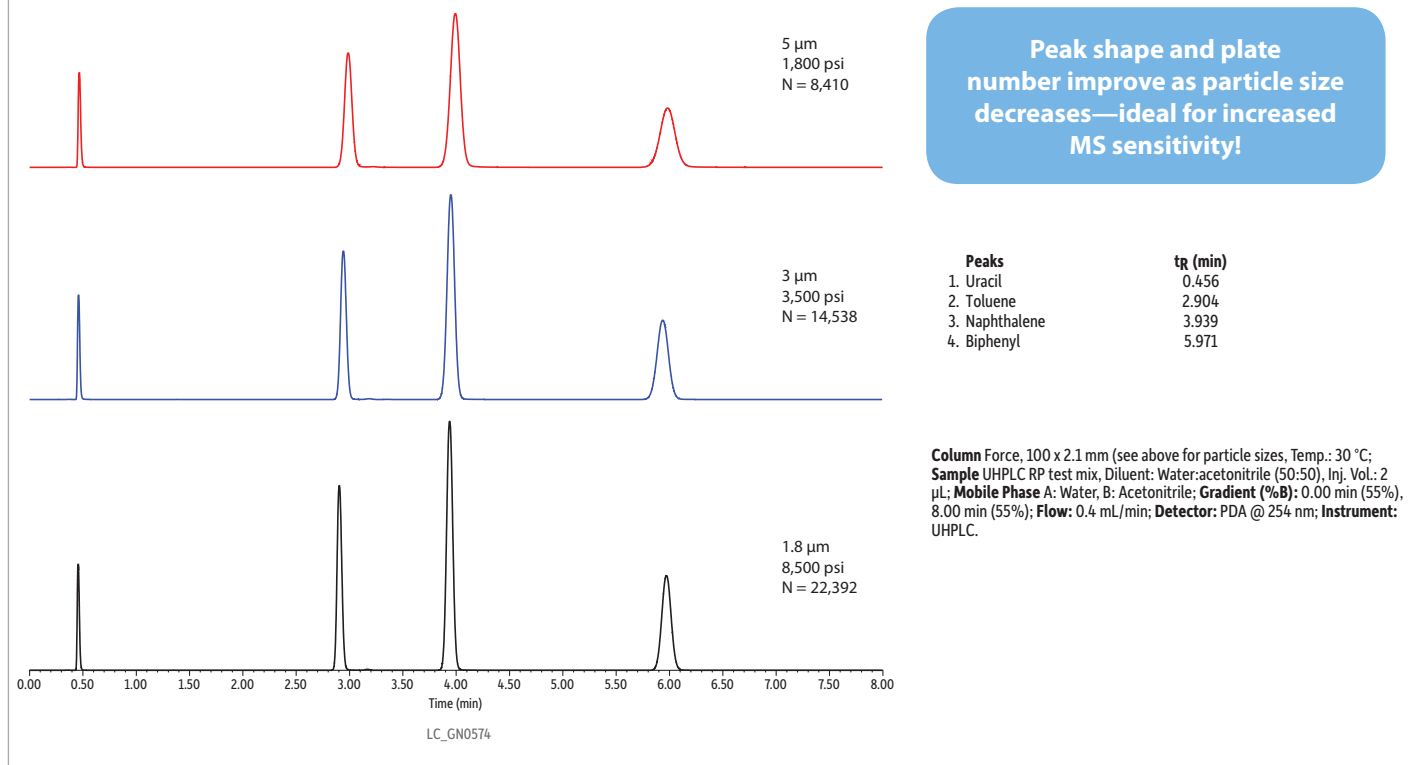

Force LC Columns at Work: *Time-Tested Restek Biphenyl Phase*

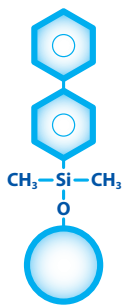

The established choice for bioanalytical testing since 2005

- Separates compounds that other phenyl and C18 chemistries can't.
- Allows the use of simple, MS-friendly mobile phases.
- Restek's most popular LC phase.

Properties:

- Increased retention for dipolar, unsaturated, or conjugated solutes.
- Enhanced selectivity when used with methanolic mobile phase.
- Ideal for increasing sensitivity and selectivity in LC-MS analyses.

Switch to a Biphenyl when:

- Limited selectivity is observed on a C18.
- You need to increase retention of hydrophilic aromatics.

Column Interaction Profile:

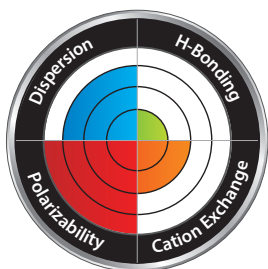

Defining Solute Interactions:

- Polarizability
- Dispersion

Complementary Solute Interaction:

- Cation exchange

Solute Retention Profile:

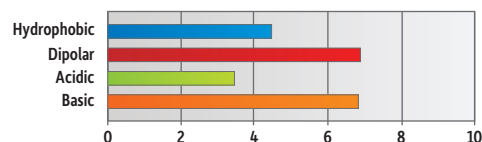

Target Analyte Structures:

- Aromatic
- Dipolar

Target Analyte Functionalities:

- Hydrophilic aromatics
- Strong dipoles
- Lewis acids
- Dipolar, unsaturated, or conjugated compounds
- Fused-ring compounds with electron withdrawing groups

Figure 33: Whether for therapeutic drug monitoring or toxicology, Force Biphenyl columns were made for applications where fast, reliable identification of drugs and metabolites could be a matter of life and death.

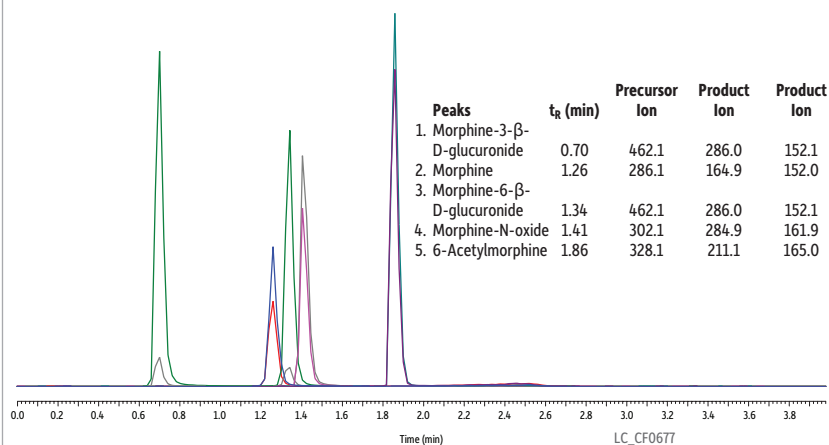

Column Force Biphenyl (cat.# 9629252), Dimensions: 50 mm x 2.1 mm ID, Particle Size: 1.8 μm, Temp.: 35 °C; **Sample** Diluent: 0.1% Formic acid in water, Conc.: 50 ng/mL, Inj. Vol.: 5 μL; **Mobile Phase** A: 0.1% Formic acid in water, B: 0.1% Formic acid in methanol; **Gradient (%B)**: 0.00 min (15%), 0.50 min (70%), 2.00 min (15%), 2.01 min (15%), 4.00 min (15%); **Flow**: 0.5 mL/min; **Detector**: MS/MS; Ion Mode: ESI+; Mode: MRM; **Instrument**: UHPLC.

Product Listing



Force Biphenyl LC Columns (USP L11)

Length	2.1 mm cat.#	3.0 mm cat.#	4.6 mm cat.#
1.8 μm Columns			
30 mm	9629232		
50 mm	9629252	962925E	
100 mm	9629212	962921E	
3 μm Columns			
30 mm	9629332		
50 mm	9629352	962935E	
100 mm	9629312	962931E	9629315
150 mm	9629362	962936E	9629365
5 μm Columns			
50 mm	9629552	962955E	
100 mm	9629512	962951E	9629515
150 mm	9629562	962956E	9629565
250 mm			9629575



Force EXP guard columns and UltraShield PreColumn filters, see page 50.

Force LC Columns at Work: *General-Purpose Restek C18 Phase*

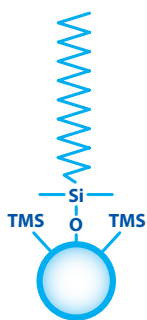

Force column dependability, scalability, and quality in a C18

- Wide pH range provides excellent data quality for many applications.
- Offers high hydrophobic retention.

Properties:

- Compatible with moderately acidic to neutral mobile phases (pH 2–8).
- Excellent data quality in food, environmental, bioanalytical, and other applications.

Switch to a C18 when:

- You need a general-purpose column for reversed-phase chromatography.
- You need to increase retention of hydrophobic compounds.

Column Interaction Profile:

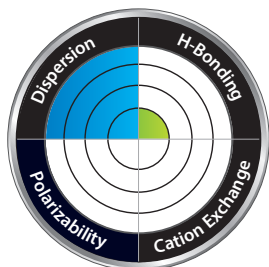

Defining Solute Interaction:

- Dispersion

Solute Retention Profile:

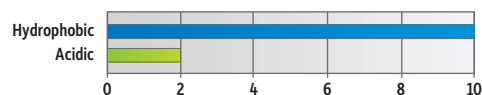

Target Analyte Structure:

- Hydrocarbons

Target Analyte Functionality:

- Hydrophobic compounds

Figure 34: A C18 is a common first choice for method developers, and as shown here for these isoflavones commonly found in nutraceuticals, a Force C18 column is the C18 to choose.

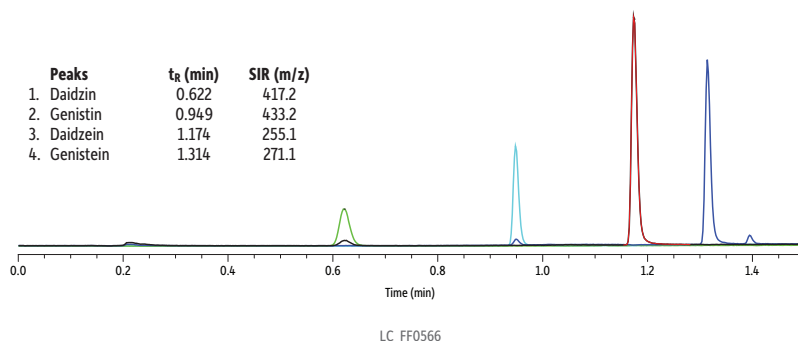

Column: Force C18 (cat.# 9634252), Dimensions: 50 mm x 2.1 mm ID, Particle Size: 1.8 μ m, Temp.: 50 °C, **Sample:** Custom mix, Diluent: Water, Inj. Vol.: 2 μ l; **Mobile Phase A:** Water + 0.1% formic acid, B: Acetonitrile + 0.1% formic acid; **Gradient (%B):** 0.00 min (15%), 1.50 min (95%), 1.51 min (15%), 3.00 min (15%); **Flow:** 0.6 mL/min; Max Pressure: 500 bar; **Detector:** MS; Interface: ESI+; **Instrument:** UHPLC.

Product Listing



Force C18 LC Columns (USP L1)

Length	2.1 mm cat.#	3.0 mm cat.#	4.6 mm cat.#
1.8 μm Columns			
30 mm	9634232		
50 mm	9634252	963425E	
100 mm	9634212	963421E	
3 μm Columns			
30 mm	9634332		
50 mm	9634352	963435E	
100 mm	9634312	963431E	9634315
150 mm	9634362	963436E	9634365
5 μm Columns			
50 mm	9634552	963455E	
100 mm	9634512	963451E	9634515
150 mm	9634562	963456E	9634565
250 mm			9634575



Force EXP guard columns and UltraShield PreColumn filters, see page 50.

Force LC Columns at Work: *Reliably Versatile Restek FluoroPhenyl Phase*



Get the power of HILIC and RP modes in one LC column



- Capable of both reversed-phase and HILIC separations.
- Ideal for increasing sensitivity and selectivity in LC-MS analyses.
- Offers increased retention for charged bases.

Properties:

- Capable of both reversed-phase and HILIC separations.
- Ideal for increasing sensitivity and selectivity in LC-MS analyses.
- Offers increased retention for charged bases.

Switch to FluoroPhenyl when:

- Limited retention and selectivity are observed on a C18 for basic compounds.
- You need increased retention of hydrophilic compounds.

Column Interaction Profile:

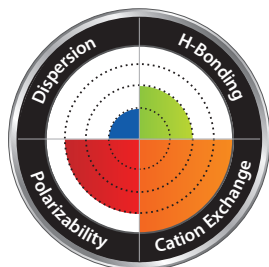

Defining Solute Interactions:

- Cation exchange

Complementary Solute Interaction:

- Polarizability
- Dispersion

Solute Retention Profile:

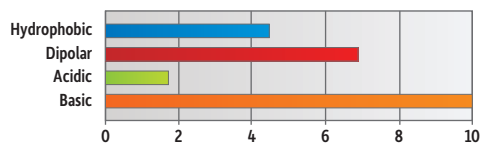

Target Analyte Structures:

- Nitrogen

Target Analyte Functionalities:

- Protonated amines
- Quaternary ammonium compounds
- Positively charged moieties
- Lewis bases

Product Listing



Force FluoroPhenyl LC Columns (USP L43)

Length	2.1 mm cat.#	3.0 mm cat.#	4.6 mm cat.#
1.8 μm Columns			
30 mm	9639232		
50 mm	9639252	963925E	
100 mm	9639212	963921E	
3 μm Columns			
30 mm	9639332		
50 mm	9639352	963935E	
100 mm	9639312	963931E	9639315
150 mm	9639362	963936E	9639365
5 μm Columns			
50 mm	9639552	963955E	
100 mm	9639512	963951E	9639515
150 mm	9639562	963956E	9639565
250 mm			9639575



Force EXP guard columns and UltraShield PreColumn filters, see page 50.

Force LC Guard Columns

Force EXP Guard Column Cartridges — for 3 and 5 µm Force Columns

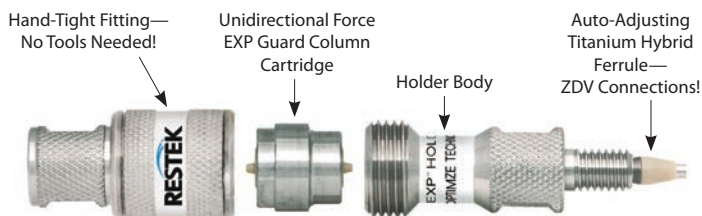

Protect your investment and extend the life of our already-rugged LC columns and change guard column cartridges by hand without breaking fluid connections—no tools needed!

- Free-Turn architecture lets you change cartridges by hand without breaking inlet/outlet fluid connections—no tools needed.
- Patented titanium hybrid ferrules can be installed repeatedly without compromising high-pressure seal.
- Auto-adjusting design provides ZDV (zero dead volume) connection to any 10-32 female port.
- Guard column cartridges require EXP direct connect holder (cat.# 25808).
- Pair with EXP hand-tight fitting (cat.# 25937–25939) for tool-free installation.
- For use with 3 or 5 µm Force LC columns. For 1.8 µm Force columns, use a 0.2 µm UltraShield filter.

Force EXP Guard Column Cartridges

Description	qty.	5 x 2.1 mm	5 x 3.0 mm	5 x 4.6 mm
		cat.#	cat.#	cat.#
Force Biphenyl EXP Guard Column Cartridge	3-pk.	962950252	962950253	962950250
Force C18 EXP Guard Column Cartridge	3-pk.	963450252	963450253	963450250
Force FluoroPhenyl EXP Guard Column Cartridge	3-pk.	963950252	963950253	963950250

Maximum cartridge pressure: 600 bar/8,700 psi.

Apply Force LC columns to all of your HPLC and UHPLC instrument platforms

at www.restek.com/force

EXP Direct Connect Holder

Description	qty.	cat.#
EXP Direct Connect Holder for EXP Guard Cartridges (includes hex-head fitting & 2 ferrules)	ea.	25808

Maximum holder pressure: 20,000 psi (1,400 bar)



Apply Force to Your LC Methods at www.restek.com/force

UltraShield UHPLC PreColumn Filter — for 1.8 µm Force Columns

- Cost-effective protection for UHPLC systems.
- Reliable way to extend column lifetime.
- Universal fit—connects easily to any brand column.
- Leak tight to 15,000 psi (1,034 bar).
- 0.5 µm or 0.2 µm stainless steel frit in a stainless steel body with PEEK ferrule.

Specifications:

Inlet/Outlet:	Female/Male 10-32
Port Geometry:	Parker (1/16 CPI)
Material:	stainless steel, PEEK ferrule
Filter:	0.5 µm or 0.2 µm stainless steel
Pressure Rating:	15,000 psig (1,034 bar)
Wrench Flat:	5/16"



Protecting your column is always recommended. Restek offers EXP guard column cartridges for our 3 and 5 µm Force LC columns, but for 1.8 µm columns, where the additional volume of a guard is an issue, reach for the UltraShield UHPLC PreColumn filter with 0.2 µm frit (Figure 35). Its minimal dead volume (1 µL) makes it recommended for UHPLC up to 15,000 psi.

Figure 35: You can pair a 1.8 µm Force column with an UltraShield precolumn filter to prolong column lifetime—without significantly altering retention times.

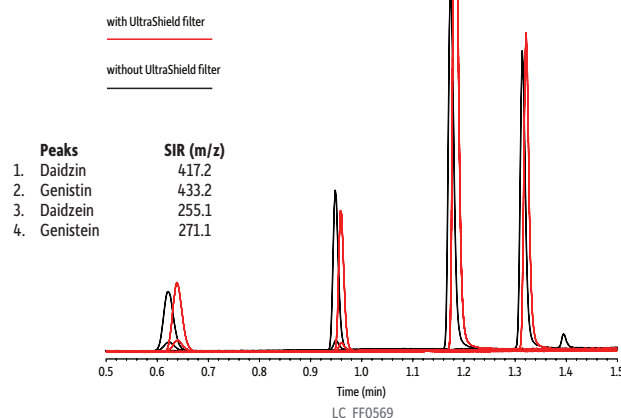

Column Force C18 (cat.# 9634252), Dimensions: 50 mm x 2.1 mm ID, Particle Size: 1.8 µm, Guard Column: UltraShield UHPLC precolumn filter 0.2 µm (cat.# 25810), Temp.: 50 °C; Sample Custom mix, Diluent: Water, Conc.: 500 ng/mL, Inj. Vol.: 2 µL; Mobile Phase A: Water + 0.1% formic acid, B: Acetonitrile + 0.1% formic acid; Gradient (%B): 0.00 min (15%), 1.50 min (95%), 1.51 min (15%), 3.00 min (15%); Flow: 0.6 mL/min; Max Pressure: 500 bar; Detector: MS; Interface: ESI+; Instrument: UHPLC.

UltraShield UHPLC PreColumn Filter

Description	Filter Porosity	qty.	cat.#
UltraShield UHPLC PreColumn Filter	0.2 µm frit	ea.	25809
		5-pk.	25810
		10-pk.	25811

Notes:

Roc LC Columns

Get more of what you want, and less of what you don't, with the reliable cornerstone of your LC lab:

- Rugged, reproducible performance.
- Exceptional value.
- 5 phases covering 98% of USP methods.
- Minimal packaging for compact storage.

www.restek.com/roc

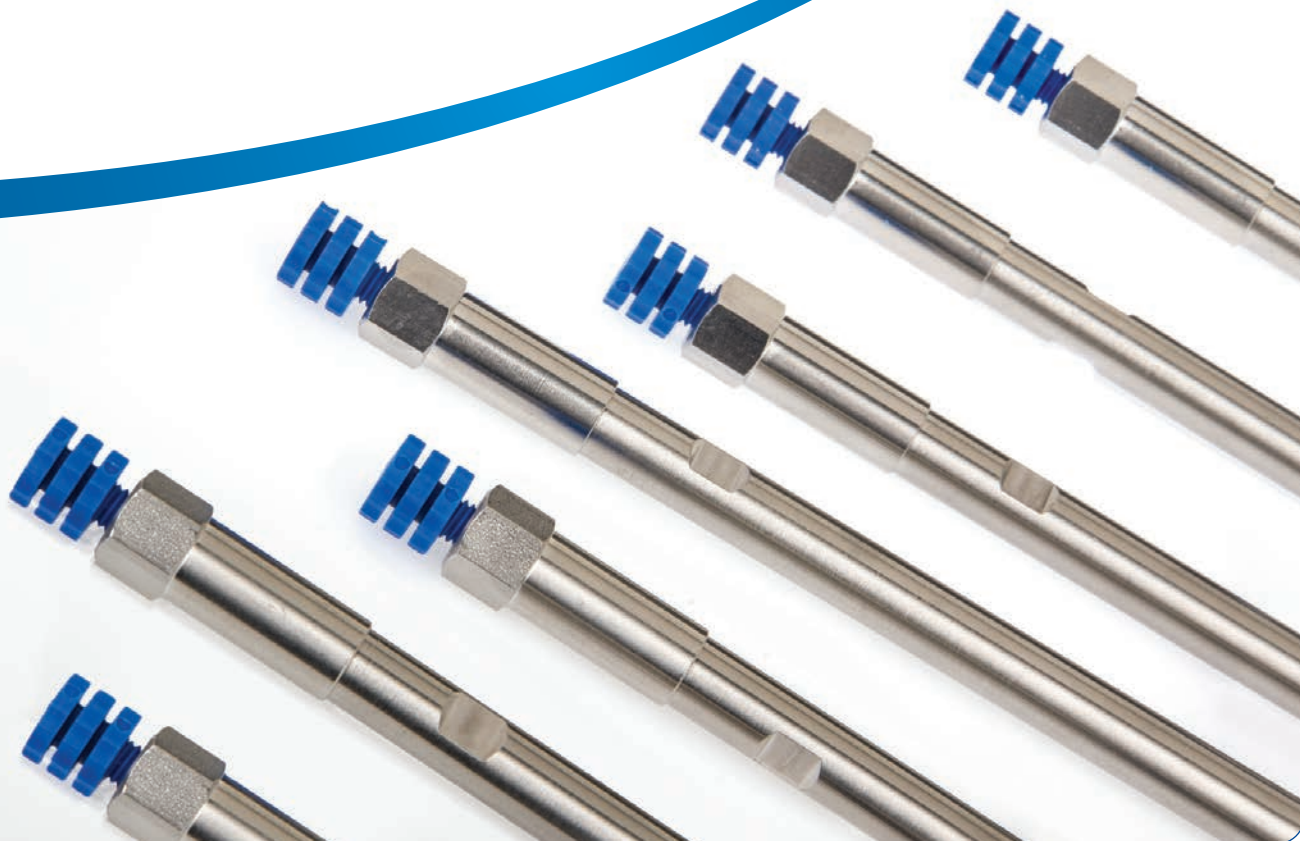

Roc LC Columns—The Reliable Cornerstone for Your LC Lab



- Conventional HPLC column built to be the cornerstone for your lab; pressure rated for any 400 bar HPLC system.
- Solid and reliable—delivers the peak shape, reproducibility, ruggedness, and performance you demand.
- Exceptional value for routine analyses and large-volume workflows—high-purity, fully porous silica backed by quality manufacturing features a variety of phases to fit most HPLC methods.
- Ideal for a wide range of applications from food to pharma; 5 phases cover 98% of USP methods.
- Newly designed minimal packaging for compact storage—download serial #-specific certificates of analysis at www.restek.com/documentation

Get more of what you want, and less of what you don't, with Roc LC columns from Restek.

Order today at www.restek.com/roc

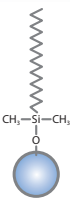
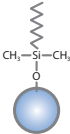
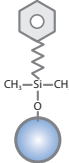
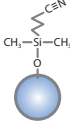

Roc Family of LC Phases

	C18	C8	Phenyl-Hexyl	Cyano	Silica
					
USP Phase Code	L1	L7	L11	L10	L3
Stationary Phase Category	C18, octadecylsilane	C8, octylsilane	phenyl	cyano	bare silica
Ligand Type	monomeric C18	monomeric C8	phenyl-hexyl	cyanopropyl	n/a
Particle Size	3 µm or 5 µm, spherical	3 µm or 5 µm, spherical	3 µm or 5 µm, spherical	3 µm or 5 µm, spherical	3 µm or 5 µm, spherical
Pore Size	100 Å	100 Å	100 Å	100 Å	100 Å
Surface Area	300 m ² /g	300 m ² /g	300 m ² /g	300 m ² /g	300 m ² /g
Carbon Load	20%	12%	15%	8%	n/a
End-Cap	yes	yes	yes	yes	n/a
pH Range	2.5 to 8.0	2.5 to 8.0	2.0 to 8.0	2.5 to 8.0	2.5 to 8.0
Maximum Temperature	80 °C	80 °C	80 °C	80 °C	80 °C

Roc On with These Dependable LC Columns

Figure 36: Over 1,000 injections and Roc HPLC columns will still offer reliable performance, regardless of which dimension your method calls for.

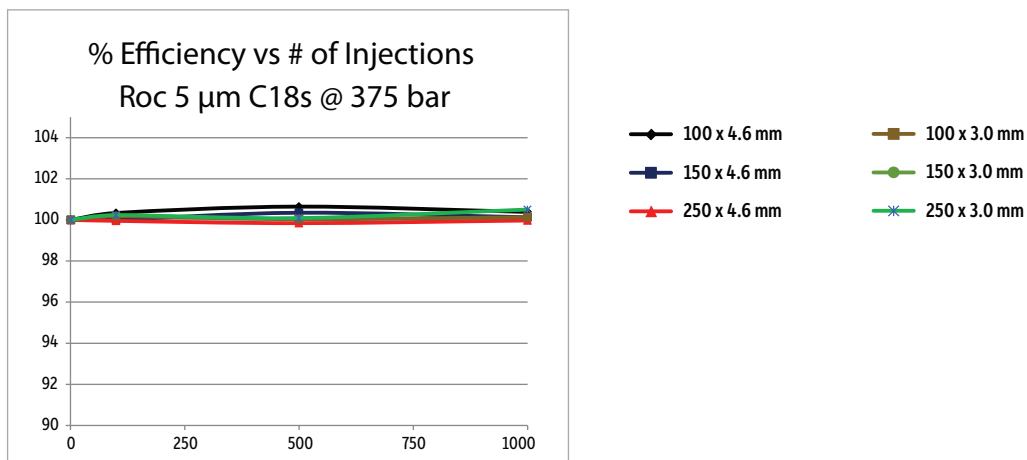
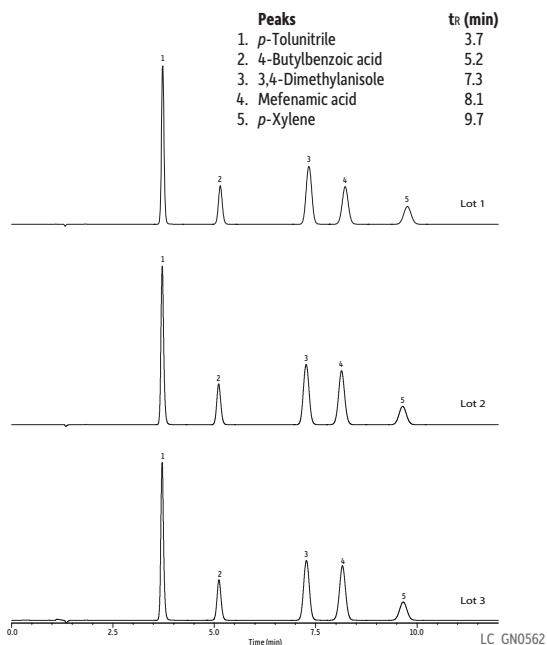

Figure 37: From one column to the next, one lot to the next, Roc columns provide results you can trust time and time again.

Reversed Phase



Column: Roc C18 (cat.# 9534565); Dimensions: 150 mm x 4.6 mm ID; Particle Size: 5 µm; Pore Size: 100 Å; Temp.: 35 °C; Inj. Vol.: 5 µL; **Mobile Phase:** 0.05% Formic acid in water:0.05% formic acid in acetonitrile (40:60); Flow: 1.0 mL/min; **Detector:** UV/Vis @ 220 nm; Cell Temp: 35 °C; **Instrument:** HPLC.

Normal Phase

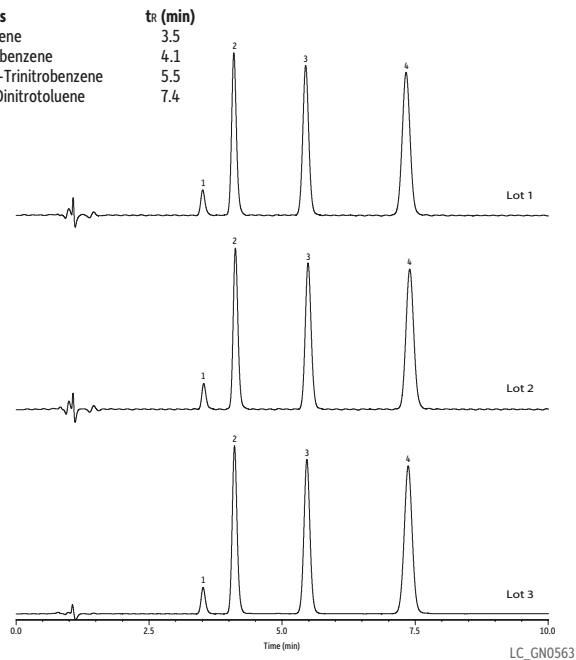

Column: Roc Cyano (cat.# 953631E); Dimensions: 100 mm x 3.0 mm ID; Particle Size: 3 µm; Pore Size: 100 Å; Temp.: 40 °C; **Sample:** Inj. Vol.: 1 µL; **Mobile Phase:** Water:acetonitrile (80:20); Flow: 0.6 mL/min; **Detector:** UV/Vis @ 254 nm; Cell Temp.: 40 °C; **Instrument:** HPLC.

Find the entire Roc HPLC column line and order now at www.restek.com/roc

Roc LC Columns from Restek

Perform Better Than or Equal To Columns from Other Vendors

Figure 38: Count on Roc LC columns from Restek for outstanding chromatographic performance.

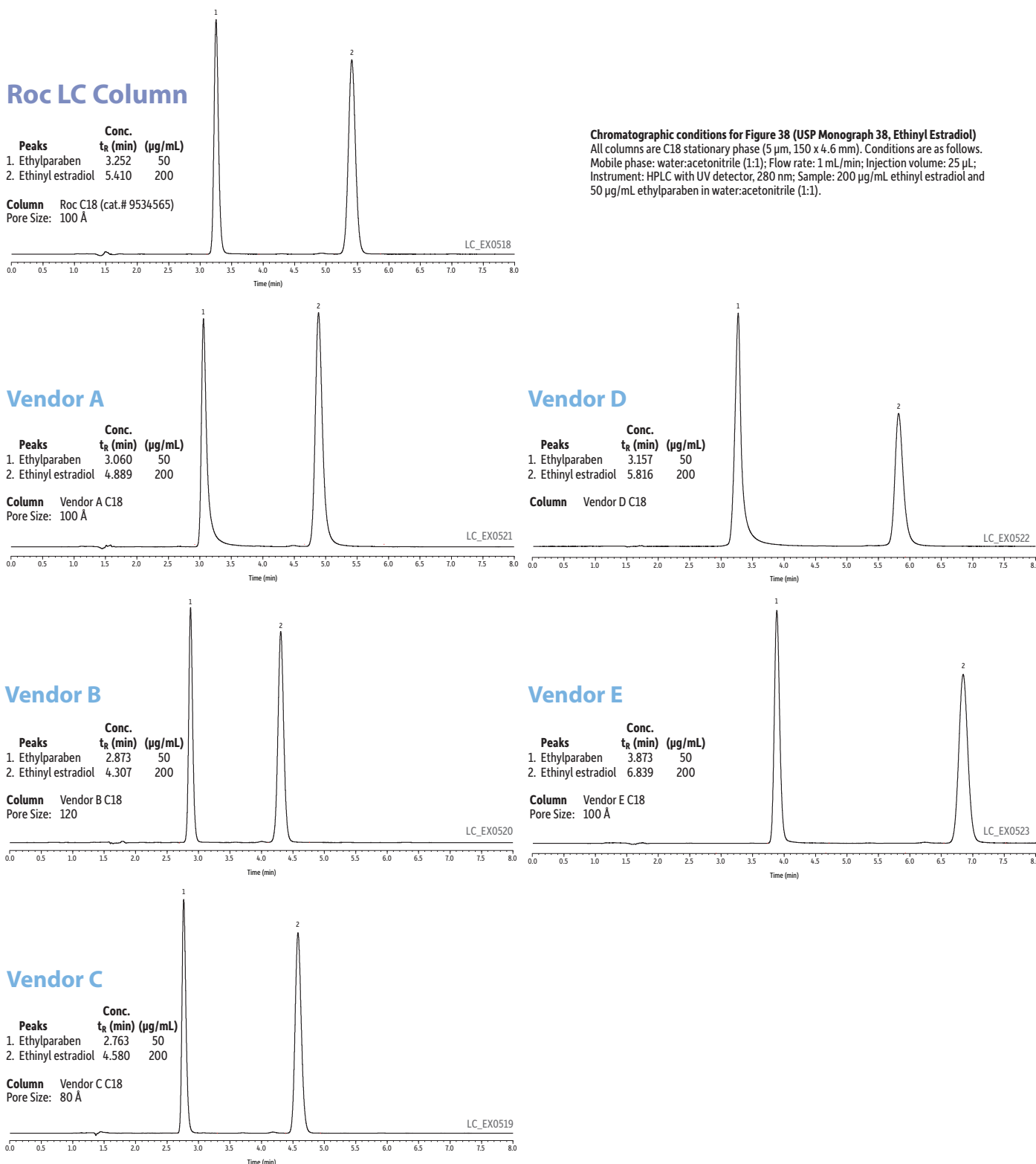

Get Roc Solid Performance

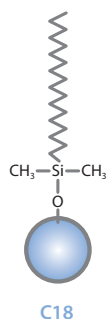

Roc C18 HPLC Columns (USP L1)

Length	3.0 mm cat.#	4.6 mm cat.#
3 μm Columns		
100 mm	953431E	9534315
150 mm	953436E	9534365
5 μm Columns		
100 mm	953451E	9534515
150 mm	953456E	9534565
250 mm	953457E	9534575

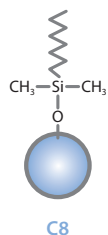

Roc C8 HPLC Columns (USP L7)

Length	3.0 mm cat.#	4.6 mm cat.#
3 μm Columns		
100 mm	953331E	9533315
150 mm	953336E	9533365
5 μm Columns		
100 mm	953351E	9533515
150 mm	953356E	9533565
250 mm	953357E	9533575

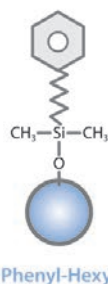

Roc Phenyl-Hexyl HPLC Columns (USP L11)

Length	3.0 mm cat.#	4.6 mm cat.#
3 μm Columns		
100 mm	953531E	9535315
150 mm	953536E	9535365
5 μm Columns		
100 mm	953551E	9535515
150 mm	953556E	9535565
250 mm	953557E	9535575

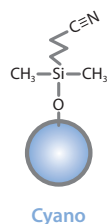

Roc Cyano HPLC Columns (USP L10)

Length	3.0 mm cat.#	4.6 mm cat.#
3 μm Columns		
100 mm	953631E	9536315
150 mm	953636E	9536365
5 μm Columns		
100 mm	953651E	9536515
150 mm	953656E	9536565
250 mm	953657E	9536575

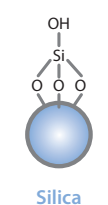

Roc Silica HPLC Columns (USP L3)

Length	3.0 mm cat.#	4.6 mm cat.#
3 μm Columns		
100 mm	953031E	9530315
150 mm	953036E	9530365
5 μm Columns		
100 mm	953051E	9530515
150 mm	953056E	9530565
250 mm	953057E	9530575

Figure 39: Add a Roc LC guard to further extend the life of your analytical column without impacting your retention, peak shape, or efficiency.

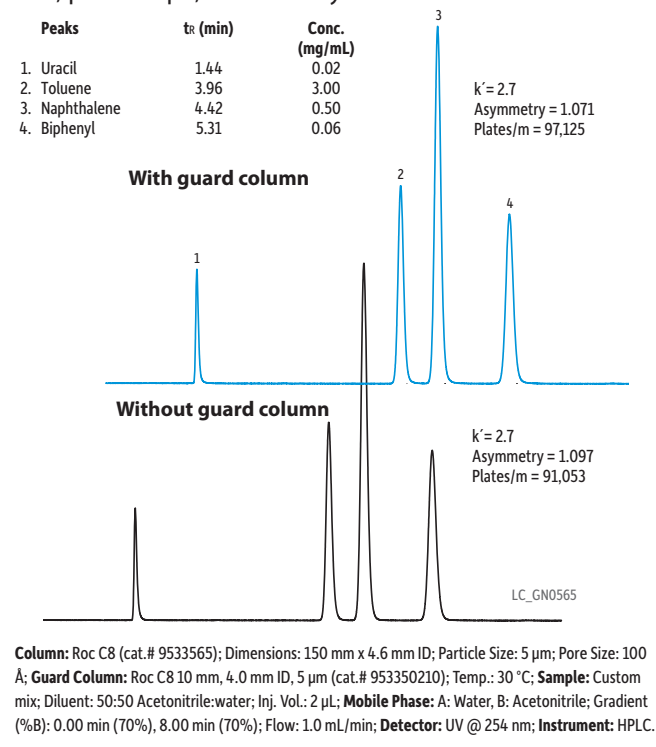

Roc LC Guard Column Cartridges

- Protect your Roc LC columns with minimal effect on retention, peak shape, or efficiency.
- Guard column cartridges require Roc guard column holder (cat.# 25812).



Description	qty.	10 x 4.0 mm cat.#
Roc C8 Guard Cartridge	3-pk.	953350210
Roc C18 Guard Cartridge	3-pk.	953450210
Roc Cyano Guard Cartridge	3-pk.	953650210
Roc Phenyl-Hexyl Guard Cartridge	3-pk.	953550210
Roc Silica Guard Cartridge	3-pk.	953050210

Roc LC Guard Column Holder



Requires separate guard column cartridges (available from Restek).

Description	qty.	cat.#
Roc LC Guard Column Holder for 10 x 4.0 mm Roc Guard Cartridges	ea.	25812

Replacement PEEK Ferrules for Roc LC Guard Column Holder



Description	qty.	cat.#
Replacement PEEK Ferrules for Roc LC Guard Column Holder	3-pk.	26391

Find the entire Roc HPLC column line and order now at www.restek.com/roc

Notes:

Keep Your Lab Flowing:

Routine Maintenance Supplies for

Agilent LCs

Replace Every Month

Bluestem Glass Solvent Filter

- Restek Bluestem glass solvent filter provides clean mobile phase to extend the life of columns and pump seals.
- 15 µm borosilicate glass frit sits lower than conventional glass filters to draw more mobile phase from each bottle.
- Blue filter stem allows instant visual confirmation of upright filter orientation.
- Connects to standard 1/8" OD (3.2 mm) PTFE tubing using your existing frit adaptor (also sold separately as cat.# 26392).

Prevent the particulates and microbial growth in your LC solvents from entering your instrument with the new Restek Bluestem glass solvent filter.

Description	Similar to Agilent Part #	qty.	cat.#
Glass Solvent Filter, 15 µm frit	5041-2168	ea.	26431
Frit Adaptor, PTFE	5062-8517	4-pk.	26392



Replace Every 3 Months

Piston Seals

for Agilent HPLC Systems

Piston seals wear out over time and Restek is your best option for economical replacements. Choose our graphite-filled PTFE seals, which are best for organic solvents.

Description	Model #	Similar to Agilent Part #	qty.	cat.#
Piston Seals, PTFE w/Graphite, Black	1050, 1100, 1200	5063-6589	2-pk.	22482
Piston Seals, PTFE w/Graphite, Black	1050, 1100, 1200	5063-6589	10-pk.	22483
Pump Block Piston Seal	1050, 1100, 1200	0905-1420	2-pk.	25918



Rotor Seals

for Agilent HPLC Systems

Description	Model #	Similar to Agilent Part #	qty.	cat.#
Rotor Seal, 400 Bar, 2-Groove	1100, 1200	0100-1853	ea.	25275
Rotor Seal (Rheodyne-Style), 3-Groove	1090	1535-4048	ea.	25349
Rotor Seal (for binary pump purge valve head)	1290	5068-0005	ea.	25782
Rotor Seal, 1200 Bar, 2-Position, 6-Port	1290	5068-0007	ea.	25768



PTFE Frits

for Agilent HPLC Systems



25466

Description	Model #	Similar to Agilent part #	qty.	cat.#
Frits, PTFE	1050, 1100, 1200	01018-22707	5-pk.	25466

Outlet Cap & Gold Seal Assembly

for Agilent HPLC Systems

Caps and seals shipped unassembled.

25890



Description	Model #	qty.	cat.#
Outlet Cap & Gold Seal Assembly	1050, 1100, 1200	2-pk.	25890

Please note: Not compatible for use with Outlet Cap and Gold Seal Assembly Tool (cat.# 24989).

Replace Every 6 Months

Active Inlet Cartridge

for Agilent HPLC Systems

Description	Model #	Similar to Agilent Part #	qty.	cat.#
Active Inlet Cartridge, 400 Bar	1050, 1100, 1200	5062-8562	ea.	26393
Active Inlet Cartridge, 600 Bar	1260, G1310B, G1311B, G1312B	G1312-60020	ea.	25766



26393



25766

Outlet Ball Valve

for Agilent HPLC Systems

Description	Model #	Similar to Agilent Part #	qty.	cat.#
Outlet Ball Valve	1050, 1100, 1200	G1311-60012	ea.	25276
Outlet Ball Valve, Binary Pump	1100, 1200	G1312-60012	ea.	25267
Outlet Check Valve	1100, 1200, 1220, 1260	G1312-60067	ea.	25765



25276



25267

Passive Inlet Valve

for Agilent 1220, 1260 LC Systems

Description	Model #	Similar to Agilent Part #	qty.	cat.#
Passive Inlet Valve	1220, 1260	G1312-60066	ea.	25763



25765



25763

Seal Wash Kit, Binary Pump

for Agilent HPLC Systems

Description	Model #	qty.	cat.#
Seal Wash Kit, Binary Pump (4 seals, 4 gaskets)	1050, 1100, 1200	kit	25268



25268

Needle Assembly

for Agilent HPLC Systems

Description	Model #	Similar to Agilent Part #	qty.	cat.#
Needle Assembly	1100, 1200	G1313-87201	ea.	25278
Needle Assembly, 900 µL	1050, 1100, 1200	G1313-87202	ea.	25916



25278



25916

Needle Seat Assembly

for Agilent HPLC Systems

Description	Model #	Similar to Agilent Part #	qty.	cat.#
Needle Seat, PEEK	1100, 1200, 1220, 1260, G1313A, G1392A/B	G1329-87017, G1313-87017	ea.	25767



25767

Replace Every 12 Months

Sapphire Pistons

for Agilent HPLC Systems

Description	Model #	Similar to Agilent Part #	qty.	cat.#
Plunger Assembly	1050, 1100, 1200, 1220, 1260	5063-6586	ea.	25273



25273

Stator Face Assembly

for Agilent HPLC Systems

Description	Model #	Similar to Agilent Part #	qty.	cat.#
Stator Face Assembly	1100, 1200	0100-1851	ea.	26424



26424

Isolation Seal

for Agilent 1100, 1200 HPLC Systems

Description	Model #	Similar to Agilent Part #	qty.	cat.#
Isolation Seal for Injection Valve	1100, 1200	0100-1852	ea.	25917



25917

Don't Forget!

Capillary Stainless Steel Tubing Assemblies

for Agilent HPLC Systems

- Precut, micro-polished tubing and pre-seated fittings for quick, easy maintenance of your Agilent HPLC systems.
- Meet or exceed manufacturer's performance.

Description	Model #	Similar to Agilent Part #	qty.	cat.#
Capillary SS Tubing with Fittings, 130 mm x 0.17 mm ID	1090	01090-87305	ea.	26525
Capillary SS Tubing with Fittings, 800 mm x 0.17 mm ID	1050	01078-87305	ea.	26526
Capillary SS Tubing with Fittings, 180 mm x 0.17 mm ID	1100	G1313-87305	ea.	26527
Capillary SS Tubing with Fittings, 700 mm x 0.25 mm ID	1050	01018-67305	ea.	26528
Capillary SS Tubing with Fittings, 700 mm x 0.25 mm ID	1050	01078-87306	ea.	26529
Capillary SS Tubing, 105 mm x 0.17 mm ID	—	5021-1816	ea.	26531
Mixing Capillary Assembly	1100	G1312-67302	ea.	26532
Capillary SS Tubing, Valve to Metering Head	1100	G1313-87301	ea.	26533
Capillary SS Tubing, 150 mm x 0.17 mm ID	—	5021-1817	ea.	26534
Capillary SS Tubing, 280 mm x 0.17 mm ID	—	5021-1818	ea.	26535
Capillary SS Tubing, 400 mm x 0.17 mm ID	—	5021-1819	ea.	26536
1/16" Fitting, Front and Back Ferrules, Stainless Steel	—	5062-2418	10-pk.	26537



26526



26527



26528

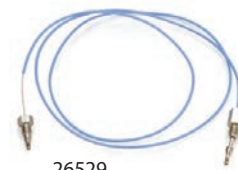

26529



26531



26532



26537



26533

Autosampler Preventive Maintenance Kit for Agilent 1100, 1200 HPLC Systems

Description	Model #	Similar to Agilent Part #	qty.	cat.#
Autosampler PM Kit Includes: rotor seal; piston seals (2); needle assembly; needle seat; finger caps (3)	1100, 1200	G1313-68709	kit	25271

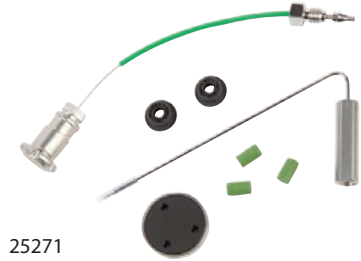

25271

Lamps for Agilent HPLC Systems

Description	Model #	Similar to Agilent Part #	qty.	cat.#
Detector Lamp, 1050 VW/DA/MWD, 1090 DA	1050, 1090	79883-60002	ea.	25260
Lamp, DAD G1315A, G1365A	1100, 1200 (Compatible with 1260.)	2140-0590	ea.	25261
Lamp, VWD G1314A	1100, 1200	G1314-60100	ea.	25262
Lamp, DAD Long-Life Deuterium (2,000 hours)	1100, 1200 DAD	5181-1530	ea.	25399
8453 Deuterium Lamp	—	2140-0605	ea.	25263
Deuterium Lamp (2,000 hours)	1100 DAD/MWD/1200 (Compatible with 1260.)	2140-0813	ea.	25888
Lamp, D2, DAD	1100 DAD, 1200 DAD	5182-1530	ea.	25771
Lamp, D2, DAD, RFID	1220 DAD, 1260, G1315C/D, G1365C/D, G7115A, G7165A	2140-0820	ea.	25764
Lamp, D2, DAD, 8-Pin RFID	1290, G4212A/B, G7117A/B/C/D	5190-0917	ea.	25769
Lamp, D2, VWD, RFID	G1314D, G1314E, G1314F, G7114A/B	G1314-60101	ea.	25770

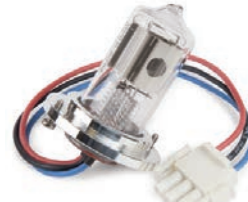

25260



25261



25262



25263



25399



25888



25771



25764



25769



25770

This is just the beginning!

There are more RM supplies for your Agilent, as well as parts for PerkinElmer, Shimadzu, Thermo, Waters, and other LCs, at www.restek.com/LCacc

Keep Your Lab Flowing:

Routine Maintenance Supplies for Shimadzu LCs

Replace Every Month

Bluestem Glass Solvent Filter

- Restek Bluestem glass solvent filter provides clean mobile phase to extend the life of columns and pump seals.
- 15 µm borosilicate glass frit sits lower than conventional glass filters to draw more mobile phase from each bottle.
- Blue filter stem allows instant visual confirmation of upright filter orientation.
- Connects to standard 1/8" OD (3.2 mm) PTFE tubing using your existing frit adaptor (also sold separately as cat.# 26392).

Prevent the particulates and microbial growth in your LC solvents from entering your instrument with the new Restek Bluestem glass solvent filter.



26431

26392

Description	Similar to Agilent Part #	qty.	cat.#
Glass Solvent Filter, 15 µm frit	5041-2168	ea.	26431
Frit Adaptor, PTFE	5062-8517	4-pk.	26392

Replace Every 3 Months

Plunger Seals

for Shimadzu HPLC Systems

Description	Model #	Similar to Shimadzu Part #	qty.	cat.#
Plunger Seal, Gold	LC-6A	228-11999-00	ea.	25285
Plunger Seal, Polyethylene, Gold	LC-10Ai, 10AS, 10AT, 10ATvp, LC-7A	228-21975-00	ea.	25290
Plunger Seal, Black	LC-10AD, 10ADvp, LC-20AD/AB, LC-600, LC-2010 A/C HT, LC-9A	228-35146-00	ea.	24980
Plunger Seal, Gold	LC-10ADvp, LC-20AD/AB	228-32628-00	ea.	24981
Plunger Seal, Black	LC-10ATvp, LC-20AT, LC-HT, SIL-10ADvp, SIL-2010 A/C HT, SIL-20A/AC, SIL-HT	228-35145-00	ea.	24985
Plunger Seal, Gold	LC-20AD XR	228-32628-91	ea.	25762
Plunger Seal w/ Back Up Ring, Gold	LC-30AD	228-52711-93	ea.	25760



24985

25762

25760

Rotor Seals

for Shimadzu HPLC Systems

Description	Model #	Similar to Shimadzu Part #	qty.	cat.#
Rotor Seal Assembly	SIL-10A, 10AXL, 10Ai	228-21217-91	ea.	25469
Rotor Seal	SIL-10ADvp	228-21217-97	ea.	24986
Rotor Seal, High-Pressure Valve (HPV)	SIL-30AC/ACMP	228-52139-00	ea.	25773
Rotor Seal, Low-Pressure Valve (LPV)	SIL-30AC/ACMP	228-51922-00	ea.	25774



25469

24986

25773

25774

Replace Every 6 Months

Inlet Check Valves

for Shimadzu HPLC Systems

Description	Model #	Similar to Shimadzu Part #	qty.	cat.#
Inlet Check Valve	LC-600, LC-9A, LC-10AD	228-18522-91, 228-33492-91	ea.	25295
Inlet Check Valve	LC-10ADvp	228-39093-92	ea.	24984
Inlet Check Valve	LC-10AT, LC-10ATvp	228-32166-91	ea.	26521
Inlet Check Valve	LC-20AD/AB XR	228-48249-91, 228-45704-91	ea.	26426
Inlet Check Valve	LC-30AD	228-52964-95	ea.	25758



25295 24984 26521 26426 25758

Outlet Check Valves

for Shimadzu HPLC Systems

Description	Model #	Similar to Shimadzu Part #	qty.	cat.#
Outlet Check Valve	LC-600, LC-9A, LC-10AD, LC-10AT	228-18522-92, 228-32531-92	ea.	25282
Outlet Check Valve	LC-10ADvp, LC-10ATvp	228-34976-91	ea.	24983
Outlet Check Valve	LC-20AD/AB XR	228-45705-91, 228-45563-91	ea.	26427
Outlet Check Valve	LC-30AD	228-53334-96	ea.	25759



25282 24983 26427 25759

Needle Seal

for Shimadzu HPLC Systems

Description	Model #	Similar to Shimadzu Part #	qty.	cat.#
Needle Seal, Vespel	LC-2010A/C, SIL-10ADvp, SIL-10AXL	228-33355-04	ea.	25468
Needle Seal, PEEK	SIL-10ADvp, 10AXL, HT	228-33355-01	ea.	25919
Needle Seal, PEEK	SIL-2010A/C HT, 20A/AC	228-42325-01	ea.	25920
Needle Seal, PEEK	SIL-30	228-53178-91	ea.	25778



25468 25919 25920 25778

Replace Every 12 Months

Sapphire Plungers

for Shimadzu HPLC Systems

Description	Model #	Similar to Shimadzu Part #	qty.	cat.#
Sapphire Plunger	LC-10AS, LC-7A	228-17019-93	ea.	25291
Sapphire Plunger	LC-600, LC-9A, LC-10AD	228-18523-91	ea.	25294
Sapphire Plunger	LC-20AT	228-35009-93	ea.	25921
Sapphire Plunger	LC-20AD/AB, LC-2010	228-35601-93	ea.	25922
Sapphire Plunger	LC-2010A/C HT, LC-HTSIL-10ADvp, SIL-20A/AC	228-35010-91	ea.	25923
Plunger, w/holder	LC-30AD	228-52069-94	ea.	25779



25291 25294 25921 25922 25923 25779

Stator Assembly

for Shimadzu HPLC Systems

Description	Model #	Similar to Shimadzu Part #	qty.	cat.#
Stator Assembly	SIL-10A, 10AXL, 10Ai	228-21220-91	ea.	25470



25470

Line Filter

for Shimadzu LC Systems

Description	Model #	Similar to Shimadzu Part #	qty.	cat.#
Line Filter, Stainless Steel	LC-30AD	228-35871-99	ea.	25761



25761

Don't Forget!

Deuterium Lamps

for Shimadzu HPLC Systems

Description	Model #	Similar to Shimadzu Part #	qty.	cat.#
Deuterium Lamp, Long-Life (2,000 hours)*	SPD-10, 10A, 10AVvp, SPD-20A, SPD-20AV	228-34016-02	ea.	25284

*Standard lamps have nominal 1,000-hour life.



25284

This is just the beginning!

There are more RM supplies for your Shimadzu, as well as parts for Agilent, PerkinElmer, Thermo, Waters, and other LCs, at www.restek.com/LCacc

Looking for LC Chromatograms? Find Them Online.

Restek's searchable chromatogram library is a comprehensive database of chromatograms by Restek chemists, partners, and customers.

- Search by compound name, synonym, CAS #, compound class, column name, catalog number, or keyword.
- Add search terms to refine your results.
- Use our quick filters to narrow your result set.

There are hundreds of LC chromatograms in our library—dive in today to find your ideal application.

www.restek.com/chromatograms



Keep Your Lab Flowing:

Routine Maintenance Supplies for

Waters ACQUITY LCs

Replace Every Month

Bluestem Glass Solvent Filter

- Restek Bluestem glass solvent filter provides clean mobile phase to extend the life of columns and pump seals.
- 15 µm borosilicate glass frit sits lower than conventional glass filters to draw more mobile phase from each bottle.
- Blue filter stem allows instant visual confirmation of upright filter orientation.
- Connects to standard 1/8" OD (3.2 mm) PTFE tubing using your existing frit adaptor (also sold separately as cat.# 26392).

Prevent the particulates and microbial growth in your LC solvents from entering your instrument with the new Restek Bluestem glass solvent filter.

Description	Similar to Agilent Part #	qty.	cat.#
Glass Solvent Filter, 15 µm frit	5041-2168	ea.	26431
Frit Adaptor, PTFE	5062-8517	4-pk.	26392



Solvent Bottle Filter for Waters ACQUITY Systems

Description	Model #	Similar to Waters Part #	qty.	cat.#
Solvent Bottle Filters	ACQUITY	700003616	7-pk.	25954



Replace Every 3 Months

Head Plunger Seal Kits for Waters HPLC Systems

Description	Model #	Similar to Waters Part #	qty.	cat.#
Head Plunger Seal Kit Includes: head plunger seals (2), back-up washers (2)	ACQUITY, nanoACQUITY	700002599	kit	26428



Replace Every 6 Months

Preventive Maintenance (PM) Kits

for Waters ACQUITY UPLC Systems

Description	Model #	Similar to Waters Part #	qty.	cat.#
<p>ACQUITY BSM Pump Kit</p> <p>Includes: in-line filter assembly, stainless steel frit; tube assembly, transducer to check valve; tube assembly, SSV to in-line filter; primary check valve (2); wash seal, float flanged, (2); head plunger seal kit (2); sapphire plungers, (2); air filter, pump; air filter, pump handle; mixer assembly, 50 µl; accumulator check valve, double ball & seat (2); solvent bottle filter, stainless steel (7); pump O-ring, (PTFE)</p>	ACQUITY UPLC BSM	201000173	kit	25797
<p>ACQUITY I2V BSM Pump Kit</p> <p>Includes: tube assembly, SSV to I2v; transducer to check valve, tube assembly, I2v; wash seal, float flanged (2); head plunger seal kit (2); sapphire plungers (2); air filter, pump; air filter, pump handle; mixer assembly, 50 µl; filter frit cartridge, stainless steel; accumulator check valve, double ball & seat (2); check valve cartridge (2); solvent bottle filter, stainless steel (7); pump O-ring, (PTFE)</p>	ACQUITY UPLC I2V BSM	201000197	kit	25798
<p>ACQUITY H-Class QSM Pump Kit</p> <p>Includes: solvent bottle filter, stainless steel (5); 20 micron frit holder assembly; tube assembly, transducer to check valve; wash seal, float flanged (2); head plunger seal kit (2); sapphire plungers (2); check valve, double ball & seat (2); I2 check valve cartridge; air filter, door; pump O-ring, (PTFE); mixer assembly, 100 µl</p>	ACQUITY H-CLASS QSM	201000233	kit	25799



Primary Check Valve for Waters ACQUITY and nanoACQUITY Systems

Description	Model #	Similar to Waters Part #	qty.	cat.#
Primary Check Valve	ACQUITY, nanoACQUITY	700002596	2-pk.	25955



Accumulator Check Valve (Double Ball & Seat) for Waters ACQUITY and nanoACQUITY Systems

Description	Model #	Similar to Waters Part #	qty.	cat.#
Accumulator Check Valve (Double Ball & Seat)	ACQUITY, nanoACQUITY	700002968	2-pk.	25956



Replace Every 12 Months

Sapphire Plunger

for Waters ACQUITY and nanoACQUITY Systems

Description	Model #	Similar to Waters Part #	qty.	cat.#
Sapphire Plunger	ACQUITY, nanoACQUITY	700002600	2-pk.	25958



25958

Pump O-Ring

for Waters ACQUITY and nanoACQUITY Systems

Description	Model #	Similar to Waters Part #	qty.	cat.#
Pump O-Ring	ACQUITY, nanoACQUITY	WAT076152	ea.	25951



25951

Needle Assembly

for Waters ACQUITY Systems

Description	Model #	Similar to Waters Part #	qty.	cat.#
Needle Assembly, 0.010 mm ID	ACQUITY	700002644	ea.	25942



25942

Needle Kit

for Waters ACQUITY Systems

Description	Model #	Similar to Waters Part #	qty.	cat.#
Needle Kit, 15 µL	ACQUITY H-class	700005215	kit	25777



25777

Don't Forget!

Lamps for Waters Detectors

Description	Model #	Similar to Waters Part #	qty.	cat.#
Lamp, D2 w/ Chip	ACQUITY, ACQUITY UPC2 PDA, ACQUITY UPLC PDA, ACQUITY UPLC TUV	700005269, 201000273	ea.	25772
Lamp, UV, Long Life (2,000 hours), D2	ACQUITY PDA/TUV 24:89/2998	201000281	ea.	25775



25772

25775

This is just the beginning!

There are more RM supplies for your Waters, as well as parts for Agilent, PerkinElmer, Shimadzu, Thermo, and other LCs, at www.restek.com/LCacc

Keep Your Lab Flowing:

Routine Maintenance Supplies for

Waters Alliance LCs

Replace Every Month

Bluestem Glass Solvent Filter

- Restek Bluestem glass solvent filter provides clean mobile phase to extend the life of columns and pump seals.
- 15 µm borosilicate glass frit sits lower than conventional glass filters to draw more mobile phase from each bottle.
- Blue filter stem allows instant visual confirmation of upright filter orientation.
- Connects to standard 1/8" OD (3.2 mm) PTFE tubing using your existing frit adaptor (also sold separately as cat.# 26392).

Prevent the particulates and microbial growth in your LC solvents from entering your instrument with the new Restek Bluestem glass solvent filter.

Description	Similar to Agilent Part #	qty.	cat.#
Glass Solvent Filter, 15 µm frit	5041-2168	ea.	26431
Frit Adaptor, PTFE	5062-8517	4-pk.	26392



Replace Every 3 Months

Vespel Rotor Seal

for Waters HPLC Systems: Rheodyne Style

Description	Model #	Similar to Waters Part #	qty.	cat.#
Vespel Rotor Seal	1090, 7000, 7010, 7040, 7067	7010-039	ea.	25279
Vespel Rotor Seal	7125, 7126, 7725, 7725i, 9725	7125-047	ea.	25280

Seal Pack Rebuild Kit (without Seal Wash Tube Assembly)

for Waters HPLC Systems

Description	Model #	Similar to Waters Part #	qty.	cat.#
Seal Pack Rebuild Kit, without Seal Wash Tube Assembly Includes: wash tube seal; seal wash tube; PTFE washer; filter retainer; lower wash seal frit; needle wash frit; TFE washer; needle; injector seal (2); compression screw; ferrule	2690, 2695	WAT271019	kit	25495

Head Plunger Seals

for Waters HPLC Systems

Description	Model #	Similar to Waters Part #	qty.	cat.#
Head Plunger Seals, Gold	2690, 2695, 2790, 2795	WAT270789, WAT270938	2-pk.	25387
Head Plunger Seals, Black	2690, 2695, 2790, 2795	WAT271066	2-pk.	25388



Replace Every 6 Months

Preventive Maintenance (PM) Kits

for Waters HPLC Systems

Description	Model #	Similar to Waters Part #	qty.	cat.#
2690/2695 Pump & Autosampler PM Kit Includes: sapphire plungers (2); seal wash plunger seals (4); head plunger seals (4); wash tube seals (4); sparge diffuser; filter insert; face seals (4); solvent reservoir 10 µm filters (4); 250 µL syringe; check valve cartridges (2); wash tube seal; seal wash tube; PTFE washer; filter retainer; lower wash seal frit; needle wash frit; TFE washer; needle assembly; gold injector seals (2); stainless steel ferrule; compression screw	Alliance 2690, 2695	WAT270944	kit	25143
717 Autosampler PM Kit Includes: seal pack assembly; tube assembly (0.020" ID); needle; needle compression screw; 0.062 stainless steel ferrule; precolumn filter assembly; filter insert; 250 µL WISP syringe	717 Autosampler	WAT052669	kit	25145
600 Pump PM Kit Includes: PerformancePLUS cartridges (4); sparge diffusers (4); Super Seals (2); solvent reservoir 10 µm filters (4); sapphire plungers (2); reference valve button; valve disk spacer; valve disk; TFE ball plug; TFE seat; ruby ball; inlet tube body assembly manifold insert; insert seal; belleville washers (2); flat washer	600 Pump	WAT052675	kit	25144
515 Pump PM Kit Includes: PerformancePLUS check valves (4); sparge diffuser; solvent reservoir 10 µm filter; sapphire plungers (2); plunger seals (2); pivot inserts (2); pivot guides (2); washer (2); plunger springs (2); retaining rings (2)	515 Pump	WAT052587	kit	26519
1525 Pump PM Kit Includes: sapphire plungers (4); check valve cartridges (8); plunger seals (4); solvent reservoir 10 µm filters (2); reference valve button; valve disk spacer; valve disk	1525 Pump	201000114	kit	26430



25143



25145



25144



26519



26430

Check Valve Cartridges

for Waters HPLC Systems

Description	Model #	Similar to Waters Part #	qty.	cat.#
Check Valve Cartridge	2690, 2695, 2790, 2795	WAT270941	2-pk.	25373



25373

PerformancePLUS Check Valve Cartridge

for Waters HPLC Systems

Description	Model #	Similar to Waters Part #	qty.	cat.#
PerformancePLUS Check Valve Cartridge	1515, 1525, 2690, 2695, 2795, 510, 515, 600, 610	700000254	2-pk.	25370



25370

Replace Every 12 Months

Sapphire Plungers

for Waters HPLC Systems

Description	Model #	Similar to Waters Part #	qty.	cat.#
Sapphire Plunger	M6KA, 510, 590, 600, 610, LC Module 1	WAT025656, WAT069511	ea.	25381
Sapphire Plunger	616, 625, 626, 1525 Micro	WAT031788	ea.	25420
Sapphire Plunger	2690, 2695, 2790, 2795, 2796	WAT270488, WAT271067, WAT270959	ea.	25385



25381



25420



25385

Don't Forget!

Lamps

for Waters Detectors

Description	Model #	Similar to Waters Part #	qty.	cat.#
Deuterium Lamp, Long Life (2,000 hours)	486	WAT080678	ea.	25410
Deuterium Lamp, Standard (1,000 hours)	996, 2996	WAT052586	ea.	25408
Deuterium Lamp, Standard (1,000 hours)	2487, 2488	WAS081142	ea.	25409
Xenon Lamp (without holder or mirror)	470		ea.	25404
Xenon Lamp	474		ea.	25405



25409

This is just the beginning!

There are more RM supplies for your Waters, as well as parts for Agilent, PerkinElmer, Shimadzu, Thermo, and other LCs, at www.restek.com/LCacc

Safe and Simple Mobile Phase Management

With Hub-Cap 4 Liter Bottle Tops and Other Restek Accessories

- Specifically designed for 4-liter bottles—less instrument downtime.
- Easiest, cleanest way to deliver mobile phases.
- Safer—contains solvent vapors better than films or tape.



Without Hub-Cap

Messy, loose-fitting tapes and films allow solvent vapors into the lab.



Hub-Cap 4 Liter Bottle Tops and Adaptors

Secure fit keeps mobile phase lines where they belong.

Description	qty.	cat.#
Hub-Cap (assembly of the bottle cap and plug)	kit	26541
Hub-Cap Multi-Pack	3-pk.	26542
Mobi-Cap Adaptor (allows use of Hub-Cap w/GL-45 solvent bottles)	ea.	27197
Hub-Cap Adaptor (allows use of the Mobi-Cap w/4 L solvent bottles)	ea.	26538
Hub-Cap Adaptor Multi-Pack	3-pk.	26539
Hub-Cap Adaptor and Mobi-Cap (for use w/GL-45 solvent bottles)	kit	26540



In Stock and Ready to Ship!

Find hundreds of other supplies & accessories for your LC at www.restek.com/LCacc



27836

Component: Material
 Insert: PTFE
 Closure: Polypropylene
 O-ring: EPDM
 Nuts: PPS
 Ferrules: ETFE
 Nut sleeves: Polypropylene



27834

Component: Material
 Screw collar: Polypropylene
 Pouring ring: Polypropylene
 Eco-cap insert: ETFE
 O-rings: EPDM
 Luer plug: Polypropylene



27851

Filter Component: Filter Material
 Housing: Polypropylene
 Filter: Cellulose, 0.2 µm
 O-ring: EPDM



27839



27841



27846



25794



25795



27849



27850

Mobi-Cap GL-45 Bottle Tops

Description	Type	Similar to VICI Part #	qty.	cat.#
Mobi-Cap for GL-45 Threaded Bottles	2-Port: holes for (1) 1/16" and (1) 1/8" OD tubing	JR-S-11001	ea.	27835
Mobi-Cap for GL-45 Threaded Bottles	3-Port: holes for (1) 1/16" and (2) 1/8" OD tubing	JR-S-11002; Agilent 5063-6531; Grace 10973, 2106324, 9541, 5130238	ea.	27836
Mobi-Cap for GL-45 Threaded Bottles	4-Port: holes for (1) 1/16" and (3) 1/8" OD tubing	JR-S-11003	ea.	27837

Eco-Cap GL-45 Bottle Tops

Description	Type	Similar to VICI Part #	qty.	cat.#
Eco-Cap for GL-45 Threaded Bottles	3-Port	JR-9000-0007	ea.	27834

Mobi-Cap GL-45 Bottle Top Kits

Description	Similar to VICI Part #	qty.	cat.#
Mobi-Cap GL-45 Bottle Top Kit Includes: Mobi-Cap (3-port); PTFE Tubing (3 m); 2 µm Sparger; 10 µm Sparger	JR-9000-0002	kit	27851
Mobi-Cap GL-45 Bottle Top Kit with 1 L Bottle Includes: Mobi-Cap (3-port); PTFE Tubing (3 m); 2 µm Sparger; 10 µm Sparger; 1 L Bottle	JR-9000-0003	kit	27852
Mobi-Cap GL-45 Bottle Top Kit with 2 L Bottle Includes: Mobi-Cap (3-port); PTFE Tubing (3 m); 2 µm Sparger; 10 µm Sparger; 2 L Bottle	JR-9000-0004	kit	27853

Bottle Top Valves and Filters

Description	Similar to VICI Part #	qty.	cat.#
Inlet Valve (no filter) for Bottle Tops	JR-S-20006	ea.	27838
Inlet Valve with 4 mm Filter for Bottle Tops	JR-S-20003	ea.	27839
Inlet Valve with 15 mm Filter for Bottle Tops	JR-S-20009	ea.	27840
Outlet Valve with 4 mm Filter for Bottle Tops	JR-S-20004	ea.	27841
Replacement 4 mm Filter for Bottle Tops	JR-S-20007	ea.	27843
Replacement 15 mm Filter for Bottle Tops	JR-S-20008	ea.	27842

PTFE Tubing

Description	Color	ID	Length	Max Pressure	Similar to VICI Part #	qty.	cat.#
PTFE Tubing	Natural	0.094" (2.4 mm)	3 m	250 psi (18 bar)	JR-T-4037-M3; Grace 20096, 3112413	ea.	27844
PTFE Tubing	Natural	0.094" (2.4 mm)	10 m	250 psi (18 bar)	JR-T-4037-M10	ea.	27846
PTFE Tubing	Natural	0.063" (1.6 mm)	3 m	500 psi (35 bar)	JR-T-6800-M3; Grace 20063, 3112412	ea.	27845
PTFE Tubing	Natural	0.063" (1.6 mm)	10 m	500 psi (35 bar)	JR-T-6800-M10	ea.	27847

Fittings and Ferrules for 1/8" & 1/16" Tubing

Description	Max Pressure	Similar to VICI Part #	qty.	cat.#
PEEK Finger-Tight Fittings for 1/8" OD Tubing, 1/4-28 Threads	500 psi (35 bar)		10-pk.	25794
ETFE Ferrules for PEEK Finger-Tight Fittings for 1/8" OD Tubing			10-pk.	25795
PEEK Finger-Tight Fittings for 1/16" Tubing, 1/4-28 Threads	1,500 psi (105 bar)	JR-20124-10	10-pk.	27849
ETFE Ferrules for PEEK Finger-Tight Fittings for 1/16" Tubing		JR-041-10	10-pk.	27850

Last Drop Mobile Phase Filter

Description	Flow capacity	Material	Porosity	Similar to VICI Part #	qty.	cat.#
Stepped Connector for use with 1.5/2.2/3.5 mm ID tubing						
Last Drop Filter	1.2 mL/min	PTFE	2.5 µm	JR-9000-0520	ea.	27814
Last Drop Filter	2.6 mL/min	PTFE	5 µm	JR-9000-0521	ea.	27815
Last Drop Filter	3.5 mL/min	PTFE	10 µm	JR-9000-0522	ea.	27816
Last Drop Filter	28 mL/min	Stainless Steel	2 µm	JR-9000-0530	ea.	27817
Last Drop Filter	30 mL/min	Stainless Steel	5 µm	JR-9000-0531	ea.	27818
Last Drop Filter	30 mL/min	Stainless Steel	10 µm	JR-9000-0532	ea.	27819
Flangeless Connector for use with 1/8" OD tubing						
Last Drop Filter	1.2 mL/min	PTFE	2.5 µm	JR-9000-0520F	ea.	27820
Last Drop Filter	2.6 mL/min	PTFE	5 µm	JR-9000-0521F	ea.	27821
Last Drop Filter	3.5 mL/min	PTFE	10 µm	JR-9000-0522F	ea.	27822
Last Drop Filter	28 mL/min	Stainless Steel	2 µm	JR-9000-0530F	ea.	27823
Last Drop Filter	30 mL/min	Stainless Steel	5 µm	JR-9000-0531F	ea.	27824
Last Drop Filter	30 mL/min	Stainless Steel	10 µm	JR-9000-0532F	ea.	27825

Flow rates measured with methanol/water (1:1), ultrasonically degassed. Flow rates can vary with solvent and tubing ID.



Mobile Phase Sparge Filters

Description	Flow capacity	Material	Porosity	Similar to VICI Part #	qty.	cat.#
Flangeless Connector for use with 1/16" OD tubing						
Sparger Filter	35 mL/min	Stainless Steel	2 µm	JR-367016-2	ea.	27827
Sparger Filter	35 mL/min	Stainless Steel	10 µm	JR-367016-10	ea.	27828
Sparger Filter	35 mL/min	Stainless Steel	20 µm	JR-367016-20	ea.	27829
Flangeless Connector for use with 1/8" OD tubing						
Sparger Filter	120 mL/min	Polyethylene	20 µm	JR-32178	ea.	27826
Sparger Filter	35 mL/min	Stainless Steel	2 µm	JR-367008-2	ea.	27830
Sparger Filter	100 mL/min	Stainless Steel	10 µm	JR-367008-10	ea.	27831
Sparger Filter	120 mL/min	Stainless Steel	20 µm	JR-367008-20	ea.	27832

Flow rates measured with methanol/water (1:1), ultrasonically degassed. Flow rates can vary with solvent and tubing ID.



PEEK Plug for Bottle Top Adaptors

Description	Similar to VICI Part #	qty.	cat.#
PEEK Plug, 1/4"-28 threads	JR-409	3-pk.	27848



Safety Exhaust Filter with Indicator

Description	Similar to VICI Part #	qty.	cat.#
Safety Exhaust Filter with Indicator for Bottle Tops	JR-S-20005	ea.	27833





26395



26396

Assembles quickly and easily!



25925

26395
Bottle not included.

Hub-Cap Filter Kit



Unscrew and lift off top.

Place membrane filter on top of grid.

Reattach top.

Connect vacuum line to side port.

Description	qty.	cat.#
Hub-Cap Filter Kit for 4 L or Wheaton bottles	kit	26395
Replacement Parts		
Polypropylene Membrane Filters (hydrophobic), 47 mm, 0.45 µm	100-pk.	26396
Polypropylene Membrane Filters (hydrophobic), 47 mm, 0.22 µm	100-pk.	26397
Nylon Membrane Filters, 47 mm, 0.45 µm	100-pk.	26398
Nylon Membrane Filters, 47 mm, 0.22 µm	100-pk.	26399
Hub-Cap Filter Hose Barb	ea.	25925

Bottle not included.

Waste Overflow Indicator

for LC Systems

- Avoid messy pooling around mobile phase waste containers.
- Audible alarm instantly alerts user, preventing overflow.
- Compact, battery-operated unit.
- Available for 4-liter and GL-45 solvent bottles.

Description	qty.	cat.#
Waste Overflow Indicator for LC Systems, 4 Liter	ea.	26543
Waste Overflow Indicator for LC Systems, GL-45	ea.	26550
Replacement AA Battery for the Waste Overflow Indicator	ea.	26544
Replacement AA Batteries for the Waste Overflow Indicator	3-pk.	26545



Bottles not included.

Bluestem Glass Solvent Filter

- Restek Bluestem glass solvent filter provides clean mobile phase to extend the life of columns and pump seals.
- 15 µm borosilicate glass frit sits lower than conventional glass filters to draw more mobile phase from each bottle.
- Blue filter stem allows instant visual confirmation of upright filter orientation.
- Connects to standard 1/8" OD (3.2 mm) PTFE tubing using your existing frit adaptor (also sold separately as cat.# 26392).

Description	Similar to Agilent Part #	qty.	cat.#
Glass Solvent Filter, 15 µm frit	5041-2168	ea.	26431
Frit Adaptor, PTFE	5062-8517	4-pk.	26392



26431



25304

Graduated Safety-Coated Bottles

Description	qty.	cat.#
Graduated Safety-Coated Bottle – GL-45 threads	ea.	25304

EXP Connectors

EXP2 Reusable Fittings for HPLC & UHPLC

for 10-32 fittings and 1/16" tubing

- Unique nut driver allows easy 20,000+ psi seals without wrenches.*
- Patented ferrule can be installed repeatedly without compromising high-pressure seal.
- Precision design provides zero-dead-volume (ZDV) connection to any 10-32 port.
- Compact design fits in tight spaces, perfect for small oven compartments and six-port injection valves.
- Non-swaged ferrules mean vendor-specific tubing is not required.
- Suitable for both HPLC and UHPLC.



Restek is pleased to offer the EXP2 fitting system from Optimize Technologies—the ultimate reusable extreme high-pressure LC connection system. Featuring a small 3/16" hex-head EXP2 nut, the new EXP2 nut driver, and the original EXP titanium hybrid ferrule, the EXP2 fitting system offers hand-tight connections rated to 20,000 psi+.

The slim EXP2 nut allows for maximum working room in small spaces, such as six-port injection valves and cramped column ovens. The EXP2 nut driver is a small, easy-to-use knurled torque driver that snaps on to the nuts for hand tightening and loosening. The EXP2 driver is slotted and can be removed from the nut and tubing after use.

The patented EXP titanium hybrid ferrule integrates the resilience of titanium with the proven sealing ability of PEEK in a high-performance, one-piece design. The hybrid ferrule provides a perfect seal with every connection, and it can be released without tools to adjust to the different port depths of various hardware. This adjustability allows repeated zero-dead-volume (ZDV) connections to be made to any 10-32 female threaded port, including Restek LC columns, six-port injection valves, and more. You no longer need to buy pre-swaged ferrules and tubing lengths that are specific to the nut manufacturer because EXP2 fittings can be used on any HPLC-grade 1/16" stainless steel tubing.

Description	qty.	cat.#
EXP2 Fitting (2 nuts, 2 ferrules, 1 driver)	2-pk.	25783
EXP2 Fitting (10 nuts, 10 ferrules, 1 driver)	10-pk.	25784
EXP2 Driver (driver only)	ea.	25785

*Rated to 20,000+ psi (1,400 bar) and tested to 30,000 psi (2,068 bar).

WARNING: Do not use EXP ferrules with standard nuts. Failure to use EXP fittings according to the included instructions may result in unsafe UHPLC connections and/or non-ZDV connections.

Note: EXP2 fittings are recommended for use with stainless steel tubing. When making connections with PEEK tubing, use original EXP hand-tight fittings or EXP hex-head fittings.

Hybrid Ferrule U.S. Patent No. 8201854, Wrench U.S. Patent No. D766055, Optimize Technologies. Optimize Technologies EXP Holders are Patent Pending. Other U.S. and Foreign Patents Pending. The Opti- prefix is a registered trademark of Optimize Technologies, Inc.

In Stock and Ready to Ship!

Find hundreds of other supplies & accessories for your LC at
www.restek.com/LCacc



25937



25938

WARNING: Do not use EXP ferrules with standard nuts. Failure to use EXP fittings according to the included instructions may result in unsafe UHPLC connections and/or non-ZDV connections.

EXP Reusable Fittings for HPLC & UHPLC for 10-32 fittings and 1/16" tubing EXP Hand-Tight Fittings

- Hand-tight fitting style achieves effortless HPLC seals—no tools needed for a 8,700+ psi seal.
- Both hand-tight and hex-head styles wrench-tighten for reliable UHPLC use up to 20,000+ psi!
- Patented ferrule can be installed repeatedly without compromising high-pressure seal.
- Hybrid design combines the durability of titanium with the sealing ability of PEEK.
- Cutting-edge system provides ZDV (zero dead volume) connection to any 10-32 female port.
- Compatible with 1/16" PEEK and stainless steel tubing.

Restek is pleased to offer the reusable EXP fitting system from Optimize Technologies for the ultimate in easy, reliable LC connections!

The patented hybrid EXP ferrule combines the durability of titanium with the sealing ability of PEEK for a swage that can be reused over and over again. And, when you choose the hand-tight fitting style, the special EXP nut offers an effortless seal up to 8,700+ psi (600+ bar)—no tools needed! For a reliable 20,000+ psi (1,400+ bar) UHPLC connection with either fitting style, simply wrench-tighten an extra 1/4 to 1/2 turn.

EXP ferrules should only be used with genuine EXP nuts. When used with an EXP nut, the EXP ferrule provides repeated ZDV (zero dead volume) connections to any 10-32 female threaded port, including Restek LC columns, 6-port injection valves, and more. To accommodate varying port depths, simply hold the tubing fully bottomed in the port and tighten as instructed.

Description	qty.	cat.#
EXP Hand-Tight Fitting (Nut w/Ferrule)	ea.	25937
EXP Hand-Tight Fitting (Nut w/Ferrule)	10-pk.	25938



25926

25927

EXP Reusable Fittings for HPLC & UHPLC for 10-32 fittings and 1/16" tubing EXP Hex-Head Fittings

Description	qty.	cat.#
EXP Std. Hex-Head Fitting (Nut w/Ferrule)	ea.	25926
EXP Std. Hex-Head Fitting (Nut w/Ferrule)	10-pk.	25927
EXP Short Hex-Head Fitting (Nut w/Ferrule)	ea.	25928
EXP Short Hex-Head Fitting (Nut w/Ferrule)	10-pk.	25929
EXP Long Hex-Head Fitting (Nut w/Ferrule)	ea.	25930
EXP Long Hex-Head Fitting (Nut w/Ferrule)	10-pk.	25931



25940

EXP Reusable Fittings for HPLC & UHPLC for 10-32 fittings and 1/16" tubing EXP Hand-Tight Coupler

Description	qty.	cat.#
EXP Hand-Tight Coupler (2 Nuts, 2 Ferrules, 1/16" x 0.005" ID Tubing)	ea.	25940



25935



25936

EXP Reusable Fittings for HPLC & UHPLC for 10-32 fittings and 1/16" tubing EXP Titanium Hybrid Replacement Ferrules

Description	qty.	cat.#
EXP Titanium Hybrid Ferrule	ea.	25935
EXP Titanium Hybrid Ferrule	10-pk.	25936

Hybrid Ferrule U.S. Patent No. 8201854, Optimize Technologies. Optimize Technologies EXP Holders are Patent Pending. Other U.S. and Foreign Patents Pending. The Opti- prefix is a registered trademark of Optimize Technologies, Inc.

Stainless Steel Tubing

Stainless Steel Fittings for UHPLC

Description	Material	Type	Max Pressure	Similar to VICI Part #	qty.	cat.#
Valco-Style Nuts	303 Stainless Steel	Short	20,000 psi (1,375 bar)	JR-ZN1	5-pk.	27727
Valco-Style Nuts	303 Stainless Steel	Medium	20,000 psi (1,375 bar)	JR-MZN1	5-pk.	27728
Valco-Style Nuts	303 Stainless Steel	Long	20,000 psi (1,375 bar)	JR-LZN1	5-pk.	27729
Valco-Style Ferrules	316 Stainless Steel	Cone-Style	20,000 psi (1,375 bar)	JR-ZF1S6	5-pk.	27730
Rheodyne-Style Nuts	316 Stainless Steel	Short	7,250 psi (500 bar)	JR-56-5	5-pk.	27731
Rheodyne-Style Nuts	316 Stainless Steel	Medium	7,250 psi (500 bar)	JR-57-5	5-pk.	27732
Rheodyne-Style Nuts	316 Stainless Steel	Long	7,250 psi (500 bar)	JR-58-5	5-pk.	27733
Rheodyne-Style Ferrules	316 Stainless Steel	Stepped-Style	7,250 psi (500 bar)	JR-60-5; Grace 77511, 2108371	5-pk.	27734
Rheodyne-Style Ferrules	316 Stainless Steel	Cone-Style	7,250 psi (500 bar)	JR-59-5	5-pk.	27735



27728



27730



27732



27734

Stainless Steel Unions, Tees, and Crosses for UHPLC

Description	Union Bore	Max Pressure	Similar to VICI Part #	qty.	cat.#
Stainless Steel Union	0.15 mm	20,000 psi (1,375 bar)	JR-ZU1XCS6	ea.	27736
Stainless Steel Union	0.25 mm	20,000 psi (1,375 bar)	JR-ZU1CS6	ea.	27737
Stainless Steel Union	0.75 mm	20,000 psi (1,375 bar)	JR-ZU1S6	ea.	27738
Stainless Steel Union	1/16"	20,000 psi (1,375 bar)	JR-ZU1T	ea.	27739
Stainless Steel Tee	0.25 mm	20,000 psi (1,375 bar)	JR-ZT1C	ea.	27740
Stainless Steel Tee	0.50 mm	20,000 psi (1,375 bar)	JR-ZT1M	ea.	27741
Stainless Steel Tee	0.75 mm	20,000 psi (1,375 bar)	JR-ZT1	ea.	27742
Stainless Steel Cross	0.25 mm	20,000 psi (1,375 bar)	JR-ZX1C	ea.	27743
Stainless Steel Cross	0.50 mm	20,000 psi (1,375 bar)	JR-ZX1M	ea.	27744
Stainless Steel Cross	0.75 mm	20,000 psi (1,375 bar)	JR-ZX1	ea.	27745



27740



27743



27745

Stainless Steel Tubing

ID	Length	Max Pressure	Similar to VICI Part #	qty.	cat.#
Standard-Grade Tubing					
0.005" (0.127 mm)	3 m	27,580 psi (1,902 bar)	JR-T-625-04-M3	ea.	27757
0.005" (0.127 mm)	10 m	27,580 psi (1,902 bar)	JR-T-625-04-M10	ea.	27758
0.007" (0.178 mm)	3 m	26,610 psi (1,835 bar)	JR-T-625-05-M3	ea.	27759
0.007" (0.178 mm)	10 m	26,610 psi (1,835 bar)	JR-T-625-05-M10	ea.	27760
0.010" (0.254 mm)	3 m	25,160 psi (1,735 bar)	JR-T-625-10-M3	ea.	27761
0.010" (0.254 mm)	10 m	25,160 psi (1,735 bar)	JR-T-625-10-M10	ea.	27762
0.020" (0.508 mm)	3 m	20,230 psi (1,395 bar)	JR-T-625-20-M3	ea.	27763
0.020" (0.508 mm)	10 m	20,230 psi (1,395 bar)	JR-T-625-20-M10	ea.	27764
0.030" (0.762 mm)	3 m	15,480 psi (1,067 bar)	JR-T-625-30-M3	ea.	27765
0.030" (0.762 mm)	10 m	15,480 psi (1,067 bar)	JR-T-625-30-M10	ea.	27766
0.040" (1.00 mm)	3 m	10,645 psi (734 bar)	JR-T-625-40-M3	ea.	27767
0.040" (1.00 mm)	10 m	10,645 psi (734 bar)	JR-T-625-40-M10	ea.	27768
Premium-Grade Tubing					
0.005" (0.127 mm)	3 m	27,580 psi (1,902 bar)	JR-TSS105-M3	ea.	27769
0.005" (0.127 mm)	10 m	27,580 psi (1,902 bar)	JR-TSS105-M10	ea.	27770
0.007" (0.178 mm)	3 m	26,610 psi (1,835 bar)	JR-TSS107-M3	ea.	27771
0.007" (0.178 mm)	10 m	26,610 psi (1,835 bar)	JR-TSS107-M10	ea.	27772
0.010" (0.254 mm)	3 m	25,160 psi (1,735 bar)	JR-TSS110-M3	ea.	27773
0.010" (0.254 mm)	10 m	25,160 psi (1,735 bar)	JR-TSS110-M10	ea.	27774
0.020" (0.508 mm)	3 m	20,230 psi (1,395 bar)	JR-TSS120-M3	ea.	27775
0.020" (0.508 mm)	10 m	20,230 psi (1,395 bar)	JR-TSS120-M10	ea.	27776
0.030" (0.762 mm)	3 m	15,480 psi (1,067 bar)	JR-TSS130-M3	ea.	27777
0.030" (0.762 mm)	10 m	15,480 psi (1,067 bar)	JR-TSS130-M10	ea.	27778
0.040" (1.00 mm)	3 m	10,645 psi (734 bar)	JR-TSS140-M3	ea.	27779
0.040" (1.00 mm)	10 m	10,645 psi (734 bar)	JR-TSS140-M10	ea.	27780



27758



Flexible Premium Grade Stainless Steel Tubing

ID	Color	Length	Max Pressure	Similar to VICI Part #	qty.	cat.#
Flexible Tubing with 1/16" Ends						
0.005" (0.127 mm)	Red	105 mm	27,580 psi (1,902 bar)	JR-T-96005	ea.	27781
0.005" (0.127 mm)	Red	150 mm	27,580 psi (1,902 bar)	JR-T-96010	ea.	27782
0.005" (0.127 mm)	Red	200 mm	27,580 psi (1,902 bar)	JR-T-96015	ea.	27783
0.005" (0.127 mm)	Red	280 mm	27,580 psi (1,902 bar)	JR-T-96020	ea.	27784
0.005" (0.127 mm)	Red	400 mm	27,580 psi (1,902 bar)	JR-T-96025	ea.	27785
0.005" (0.127 mm)	Red	600 mm	27,580 psi (1,902 bar)	JR-T-96030	ea.	27786
0.005" (0.127 mm)	Red	700 mm	27,580 psi (1,902 bar)	JR-T-96035	ea.	27787
0.005" (0.127 mm)	Red	800 mm	27,580 psi (1,902 bar)	JR-T-96040	ea.	27788
0.007" (0.178 mm)	Yellow	105 mm	26,610 psi (1,835 bar)	JR-T-96105	ea.	27789
0.007" (0.178 mm)	Yellow	150 mm	26,610 psi (1,835 bar)	JR-T-96110	ea.	27790
0.007" (0.178 mm)	Yellow	200 mm	26,610 psi (1,835 bar)	JR-T-96115	ea.	27791
0.007" (0.178 mm)	Yellow	280 mm	26,610 psi (1,835 bar)	JR-T-96120	ea.	27792
0.007" (0.178 mm)	Yellow	400 mm	26,610 psi (1,835 bar)	JR-T-96125	ea.	27793
0.007" (0.178 mm)	Yellow	600 mm	26,610 psi (1,835 bar)	JR-T-96130	ea.	27794
0.007" (0.178 mm)	Yellow	700 mm	26,610 psi (1,835 bar)	JR-T-96135	ea.	27795
0.007" (0.178 mm)	Yellow	800 mm	26,610 psi (1,835 bar)	JR-T-96140	ea.	27796
0.007" (0.178 mm)	Yellow	900 mm	26,610 psi (1,835 bar)	JR-T-96145	ea.	27797
0.010" (0.254 mm)	Blue	105 mm	25,160 psi (1,735 bar)	JR-T-96205	ea.	27798
0.010" (0.254 mm)	Blue	150 mm	25,160 psi (1,735 bar)	JR-T-96210	ea.	27799
0.010" (0.254 mm)	Blue	200 mm	25,160 psi (1,735 bar)	JR-T-96215	ea.	27800
0.010" (0.254 mm)	Blue	280 mm	25,160 psi (1,735 bar)	JR-T-96220	ea.	27801
0.010" (0.254 mm)	Blue	400 mm	25,160 psi (1,735 bar)	JR-T-96225	ea.	27802
0.010" (0.254 mm)	Blue	600 mm	25,160 psi (1,735 bar)	JR-T-96230	ea.	27803
0.010" (0.254 mm)	Blue	700 mm	25,160 psi (1,735 bar)	JR-T-96235	ea.	27804
0.010" (0.254 mm)	Blue	800 mm	25,160 psi (1,735 bar)	JR-T-96240	ea.	27805
0.020" (0.508 mm)	Orange	105 mm	20,230 psi (1,395 bar)	JR-T-96305	ea.	27806
0.020" (0.508 mm)	Orange	150 mm	20,230 psi (1,395 bar)	JR-T-96310	ea.	27807
0.020" (0.508 mm)	Orange	200 mm	20,230 psi (1,395 bar)	JR-T-96315	ea.	27808
0.020" (0.508 mm)	Orange	280 mm	20,230 psi (1,395 bar)	JR-T-96320	ea.	27809
0.020" (0.508 mm)	Orange	400 mm	20,230 psi (1,395 bar)	JR-T-96325	ea.	27810
0.020" (0.508 mm)	Orange	600 mm	20,230 psi (1,395 bar)	JR-T-96330	ea.	27811
0.020" (0.508 mm)	Orange	700 mm	20,230 psi (1,395 bar)	JR-T-96335	ea.	27812
0.020" (0.508 mm)	Orange	800 mm	20,230 psi (1,395 bar)	JR-T-96340	ea.	27813

PEEK Tubing, Connectors, and Fittings

Universal 10-32 PEEK Column Connectors

Universal PEEK connectors allow easy installation of all 1/16" tubing, including stainless steel, up to 5,000 psi.

Description	qty.	cat.#
PEEK Finger-Tight Fittings (blue, flat-sided)	10-pk.	27710
PEEK Finger-Tight Fittings (blue, flat-sided)	25-pk.	27711



PEEK Column Couplers

Description	Color	Union Bore	Max Pressure	Similar to VICI Part #	qty.	cat.#
PEEK Column Coupler	Red	0.13 mm	5,000 psi (350 bar)	JR-26501	ea.	27724
PEEK Column Coupler	Yellow	0.17 mm	5,000 psi (350 bar)	JR-26502	ea.	27725
PEEK Column Coupler	Blue	0.25 mm	5,000 psi (350 bar)	JR-26503	ea.	27726

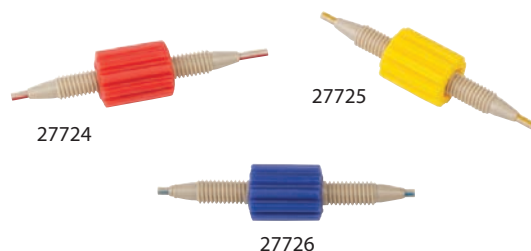

Survival Kit for HPLC, PEEK

For start-up and maintenance in all HPLC systems.

Kit includes:

- PEEK Column Connector (beige, round body), 10-pk.
- PEEK Tubing, 1/16" OD x 0.005" ID x 3 m (red stripe), ea.
- PEEK Tubing, 1/16" OD x 0.007" ID x 3 m (yellow stripe), ea.
- PEEK Tubing, 1/16" OD x 0.010" ID x 3 m (blue stripe), ea.
- PEEK Tubing Elbow, 90°, 5-pk.
- PEEK Tubing Elbow, 180°, 5-pk.
- PTFE Tubing, 1/8" OD x 0.063" (1.6 mm) ID x ea.
- PTFE Tubing, 1/8" OD x 0.094" (2.4 mm) ID x ea.
- Tubing Clip, 5-pk.
- ValvTool Wrench, ea.
- Open-End Wrenches, 1/4" x 5/16", 2-pk.*
- Clean-Cut Tubing Cutter, ea.
- Replacement Blade for Clean-Cut Cutter, ea.
- PEEK Union Connector 1/16", 2-pk.
- Mobile Phase Sparge Filter, 2 µm, ea.
- Mobile Phase Sparge Filter, 10 µm, ea.

The PEEK Survival Kit is an invaluable parts kit that contains tubing, fittings, and tools essential for setting up and maintaining your HPLC system: PEEK tubing, connectors, and elbows, PTFE tubing, a tubing cutter and extra blades, a ValvTool wrench, open-end wrenches, and more.



Description	qty.	cat.#
Survival Kit for HPLC, PEEK	kit	25322

*Kit contains 1 wrench, replacement (cat.# 20110) is a 2-pk.

In Stock and Ready to Ship!

Find hundreds of other supplies & accessories for your LC at www.restek.com/LCacc



27714

PPS Hex-Head Fittings for HPLC

Description	Color	Type	Max Pressure	Similar to VICI Part #	qty.	cat.#
PPS Fittings	Black	Hex-Head	5,000 psi (350 bar)	JR-58000-5	10-pk.	27714



27712

PEEK Hex-Head Fittings for HPLC

Description	Color	Type	Max Pressure	Similar to VICI Part #	qty.	cat.#
PEEK Fittings	Natural	Hex-Head	5,000 psi (350 bar)	JR-55100-5	10-pk.	27712



27713

PEEK-HT Hex-Head Fittings for HPLC and UHPLC

Description	Color	Type	Max Pressure	Similar to VICI Part #	qty.	cat.#
PEEK-HT Fittings with Driver	Natural	Hex-Head	10,000 psi (689 bar)	JR-5520N-10	10-pk.	27713

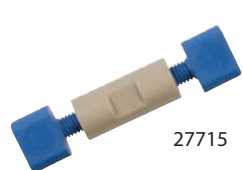

27715



27718

PEEK Unions, Tees, and Crosses for HPLC

Description	Union Bore	Max Pressure	Similar to VICI Part #	qty.	cat.#
PEEK Union	0.25 mm	5,000 psi (350 bar)	JR-1061; Agilent 0100-2441; Grace 32141, 3112487	2-pk.	27715
PEEK Union	0.50 mm	5,000 psi (350 bar)	JR-1066	2-pk.	27716
PEEK Union	0.75 mm	5,000 psi (350 bar)	JR-1067	2-pk.	27717
PEEK Tee	0.25 mm	5,000 psi (350 bar)	JR-1030	ea.	27718
PEEK Tee	0.50 mm	5,000 psi (350 bar)	JR-1032	ea.	27719
PEEK Tee	0.75 mm	5,000 psi (350 bar)	JR-1033	ea.	27720
PEEK Cross	0.25 mm	5,000 psi (350 bar)	JR-1040	ea.	27721
PEEK Cross	0.50 mm	5,000 psi (350 bar)	JR-1042	ea.	27722
PEEK Cross	0.75 mm	5,000 psi (350 bar)	JR-1043	ea.	27723



27721



27747

PEEK Tubing

Description	Color	ID	Length	Max Pressure	Similar to VICI Part #	qty.	cat.#
PEEK Tubing	Natural	0.0025"	1 m	7,000 psi	JR-T-5764-M1	3-pk.	27746
PEEK Tubing	Red Stripe	0.005"	3 m	7,000 psi	JR-T-5999-M3; Agilent 5042-6461; Grace AL35720, 5131751	ea.	27747
PEEK Tubing	Red Stripe	0.005"	10 m	7,000 psi	JT-T-5999-M10	ea.	27748
PEEK Tubing	Yellow Stripe	0.007"	3 m	7,000 psi	JR-T-6000-M3; Agilent 0890-1763; Grace AL35722, 5131753	ea.	27749
PEEK Tubing	Yellow Stripe	0.007"	10 m	7,000 psi	JR-T-6000-M10	ea.	27750
PEEK Tubing	Blue Stripe	0.010"	3 m	5,000 psi	JR-T-6001-M3; Grace AL35728, 5131759	ea.	27751
PEEK Tubing	Blue Stripe	0.010"	10 m	5,000 psi	JR-T-6001-M10	ea.	27752
PEEK Tubing	Orange Stripe	0.020"	3 m	5,000 psi	JR-T-6002-M3; Grace AL35726, 5131757	ea.	27753
PEEK Tubing	Orange Stripe	0.020"	10 m	5,000 psi	JR-T-6002-M10	ea.	27754
PEEK Tubing	Green Stripe	0.030"	3 m	5,000 psi	JR-T-6003-M3	ea.	27755
PEEK Tubing	Green Stripe	0.030"	10 m	5,000 psi	JR-T-6003-M10	ea.	27756

Well Plates & Mats

Well Plates

- Polypropylene plates with round-bottom wells reduce liquid retention; conical bottom provides optimal recovery of reagents.
- Nunc shared wall technology allows increased well volume for optimum storage capacity and improved mixing.
- Round well shape is ideal for applications that require vortexing.
- Ideal for sample collection, storage, sampling, and combinatorial chemistry and library applications.
- Fits most autosampler compartments.
- All microplates manufactured by Nunc meet the recommendation of American National Standards Institute (ANSI) (ANSI/SBS 1-2004).



26494

Description	Well Shape	Well Bottom	qty.	cat.#
0.45 mL 96-Well Plates	round	conical	case of 120	26496
1.3 mL 96-Well Plates	round	round	case of 50	26494
2.0 mL 96-Well Plates	round	round	case of 60	26492

Universal Sealing Mats

- Protect contents and prevent carryover with pre-slit cap mats.
- Chemically resistant, silicone mats are excellent for compound storage to -80 °C.
- Pre-slit mats pierceable by autosampler needle, pipette tip, or probe.
- Universal mat for sealing 0.45, 1.3, and 2.0 mL plates.



26498

Description	qty.	cat.#
Universal Sealing Mat	case of 50	26498

Fast, Painless, Effective
96-Well Plate
Sample Prep







Resprep PPT3 96-Well Plates
Protein and Particulate Removal
That's Fast, Painless, and Effective
www.restek.com/ppt3



Resprep VM-96 Vacuum Manifold
Designed with Simple Things in
Mind: Performance, Versatility,
Ergonomics, Accuracy
www.restek.com/vm-96

Trident LC Column Protection

for Ultra, Viva, and Pinnacle DB LC Columns



27475



27471



27473



27475

Upgrade to a new

Trident LC Column Protection System

- Match your needs with three levels of protection: filter only, cartridge only, or filter and cartridge.
- Durable metal tip with replaceable PEEK ferrule means easy installation onto column without tools.
- Improved thread design and materials create an optimal seal that releases and reseals easily, allowing multiple installations without galling and binding.
- Easy-to-remove cap frit simplifies filter replacement.
- Direct connection eliminates tubing and connectors that increase system volume and leak potential.
- Low-dead-volume design has negligible effect on chromatography.



Description	qty.	cat.#
Level 1: Filter Holder Only Includes: filter holder; cap frit filter (4 mm, 2.0 µm); and PEEK ferrule	4-pk.	27471
Level 2: Cartridge Holder Only Includes: cartridge holder and PEEK ferrule	4-pk.	27473
Level 3: Filter Holder and Cartridge Holder Power Pack Includes: filter holder; cap frit filter (4 mm, 2.0 µm); cartridge holder; and PEEK ferrule	4-pk.	27475

* Fittings on all HPLC and UHPLC columns have 10-32 threads; however, seat depth varies. An improper seat will yield a poor connection and may affect chromatography. While all Restek LC columns will provide a zero-dead-volume connection when used with a properly installed Trident LC column protection system, analysts should consult the manufacturer for non-Restek column connections. A detailed discussion about port configurations can be found at http://www.restek.com/Pages/faq_lc#top

In Stock and Ready to Ship!

Find hundreds of other supplies & accessories for your LC at www.restek.com/LCacc

Tables and Reference

Optimal Flow Rates

Column ID (mm)	Optimal flow rate (mL/min)*					
	1.8 μ m dp	3 μ m dp	5 μ m dp	1.8 μ m Raptor	2.7 μ m Raptor	5 μ m Raptor
4.6	—	1.5	1.0	—	1.6	1.0
3.2	—	—	0.5	—	—	—
3.0	1.1	0.6	0.4	1.0	0.7	0.4
2.1	0.5	0.3	0.2	0.5	0.3	0.2
1.0	—	0.07	0.05	—	—	—

* Optimal flow rates are mobile phase dependent; table above is provided as a guide.

Common Classifications for LC Columns by Internal Diameter

Classification	Internal Diameter
Capillary	<1.0 mm ID
Micro bore	1.0 mm ID
Narrow bore	2.1–3.0 mm ID
Standard bore	3.2–4.6 mm ID
Semi-prep	10–21.2 mm ID
Prep	30–50 mm ID

HPLC Pump Pressure Conversion Table

Pressure	psi	atm	kg/cm ²	torr	kPa	bar	inches Hg
1 psi =	1	0.068	0.0703	51.713	6.8948	0.06895	2.0359
1 atm =	14.696	1	1.0332	760	101.32	1.0133	29.921
1 kg/cm ² =	14.223	0.967	1	735.5	98.06	0.9806	28.958
1 torr =	0.0193	0.00132	0.00136	1	0.1330	0.00133	0.0394
1 kPa =	0.1450	0.00987	0.0102	7.52	1	0.0100	0.2962
1 bar =	14.5038	0.9869	1.0197	751.88	100	1	29.5300
1 in Hg =	0.49612	0.0334	0.0345	25.400	3.376	0.03376	1

To convert a pressure, multiply the units in the left-most column by the conversion factors listed in the columns to the right.

For example: 10 psi x 0.068 = 0.68 atm
10 bar x 29.5300 = 295.300 inches Hg

Solvent Miscibility and Solubility

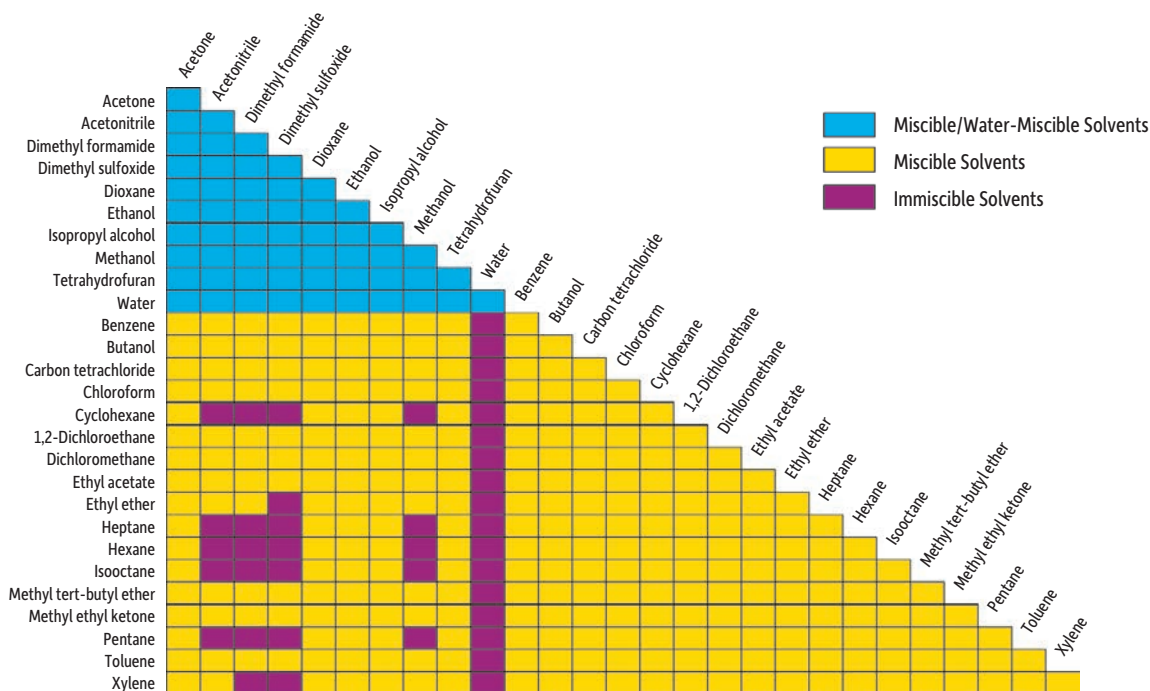

LC Columns Physical Characteristics Chart

UHPLC Columns

Restek Column	End Cap?	Pore Size (Å)	Carbon Load (%)	Surface Area (m ² /g)	pH Range	Applications	Chromatographic Properties	Similar Phases	USP Code
Raptor Biphenyl	Y	90	7	1.8 µm: 125	1.5 to 8.0	Ideal for bioanalytical and forensic toxicology testing applications like therapeutic drug monitoring (TDM), drugs of abuse, and metabolite analyses with UHPLC-MS/MS.	Increased retention for dipolar, unsaturated, or conjugated compounds. Enhanced selectivity when used with methanolic mobile phase vs ACN. Provides increased peak capacity compared to fully porous particles for increased resolution of complex samples.	Ascentis Express Biphenyl (2.7 µm), Kinetex Biphenyl	L11
Raptor ARC-18	N	90	7	1.8 µm: 125	1.0 to 8.0	Recommended for high-throughput UHPLC-MS/MS applications with acidic mobile phases. Ideal for large, multiclass analyte lists including pesticides, vitamins, and amino acids.	Well-balanced retention profile emphasizing dispersion and hydrophobic interaction. Sterically protected ligand resists acid hydrolysis to withstand harsh, low-pH mobile phases used in UHPLC-MS/MS.	Ascentis Express Peptide ES-C18, Kinetex XB-C18, Poroshell 120 SB-C18, Accucore Vanquish C18+, Accucore XL C18 (1.5 µm)	L1
Raptor C18	Y	90	9	1.8 µm: 125	2.0 to 8.0	The "go-to" phase for a variety of compound types provides excellent data quality for food safety and quality, environmental, bioanalytical, and other applications.	A traditional end-capped C18 ideal for general-purpose use in reversed-phase chromatography. Increased retention of hydrophobic compounds provides excellent data quality with methanol and ACN mobile phases.	Accucore Vanquish C18+, Accucore XL C18 (1.5 µm), Ascentis Express C18, Cortecs C18, Halo-2 C18, Kinetex C18, Poroshell 120 EC-C18	L1
Raptor FluoroPhenyl	N	90	4	1.8 µm: 125	2.0 to 8.0	Capable of running in reversed phase or HILIC mode for compounds like vitamin D epimers not well resolved on traditional C18 phases. Ideal for charged bases such as taxane drugs and other amine-containing compounds.	Electron-withdrawing fluorine atoms provide increased retention for charged bases. Reliable and efficient with acidic mobile phases for increasing selectivity and sensitivity in UHPLC-MS/MS analyses running in reversed phase or HILIC mode.	Ascentis Express F5, Halo-2 PFP, Kinetex F5, Poroshell PFP	L43
Force C18	Y	100	20	300	2.0 to 8.0	Highly hydrophobic retentive with a pH range of between 2.0 to 8.0 suitable for the analysis of a wide range of compounds.	Traditional end-capped C18 ideal for general-purpose reversed-phase use. Scalable from 1.8 µm to 3 µm to 5 µm for predictable method transfer from HPLC to UHPLC.	ACQUITY UPLC HSS C18, Develosil C18 (3 µm and 5 µm), Discovery C18, Hypersil Gold C18, Hypersil Gold Vanquish (1.9 µm), Inertsil ODS-2, Kromasil C18, LiChrospher RP-18, Luna C18, Luna Omega C18 (1.6 µm), Symmetry C18, Synchronis C18 (1.7 µm), Titan C18 (1.9 µm), Zorbax Eclipse Plus C18, Zorbax Eclipse XDB-C18, Zorbax RRHD Eclipse Plus C18 (1.8 µm), Zorbax RRHD Eclipse XDB-C18 (1.8 µm)	L1
Force Biphenyl	Y	100	15	300	2.0 to 8.0	Ideal for bioanalytical testing applications like drug and metabolite analyses. Heightened selectivity and retention for compounds that are hard to resolve or elute early on C18 and other phenyl chemistries.	Increased retention for dipolar, unsaturated, or conjugated compounds. Enhanced selectivity when used with methanolic mobile phase vs ACN. Provides increased sensitivity and selectivity for LC-MS/MS analyses. Scalable from 1.8 µm to 3 µm to 5 µm for predictable method transfer from HPLC to UHPLC.	Unique	L11
Force FluoroPhenyl	N	100	10	300	2.0 to 8.0	Reversed-phase or HILIC applications for a variety of compounds. Ideal for charged bases and other amine-containing compounds like xanthenes and nitrofurans.	Electron-withdrawing fluorine atoms provide increased retention for charged bases. Reliable and efficient with acidic mobile phases for increasing selectivity and sensitivity in LC-MS/MS analyses running in reversed-phase or HILIC mode. Scalable from 1.8 µm to 3 µm to 5 µm for predictable method transfer from HPLC to UHPLC.	ACQUITY UPLC HSS PFP, Discovery HS F5, Hypersil Gold PFP, Hypersil Gold Vanquish PFP (1.9 µm), Luna PFP (2), Pursuit PFP, Titan PFP (1.9 µm)	L43
Pinnacle DB C8	Y	140	6	150	2.5 to 8.0	Applications similar to Pinnacle DB C18, but with less hydrophobic retention. Less retention can be useful for shortening analysis time, if resolution is adequate.	Highly base-deactivated spherical silica manufactured by Restek. Monomeric C8 bonding. Similar to Pinnacle DB C18, but the shorter alkyl chain provides less hydrophobic retention.	Spherisorb C8, Zorbax C8	L7
Pinnacle DB C18	Y	140	11	150	2.5 to 8.0	Hydrophobic C18 phase suitable for analyses of a wide range of compounds, from acidic through slightly basic.	Highly base-deactivated spherical silica manufactured by Restek Monomeric C18 bonding.	Spherisorb ODS, Zorbax ODS	L1
Pinnacle DB Aqueous C18	N	140	6	150	2.5 to 8.0	Ideal for applications that require highly aqueous mobile phases, such as organic acids and water-soluble vitamins.	Highly selective phase for polar analytes. Compatible with highly aqueous (up to 100%) mobile phases. Silica manufactured by Restek.	Aquasil C18, AQUA C18, Hypersil Gold AQ, YMC ODS-AQ	L1
Pinnacle DB Biphenyl	Y	140	8	150	2.5 to 8.0	Excellent choice for the analysis of steroids, tetracyclines, drug metabolites, and other compounds that contain some degree of unsaturation.	Highly base-deactivated spherical silica manufactured by Restek. Unique reversed-phase material that displays both increased retention and selectivity for aromatic and/or unsaturated compounds when compared to conventional alkyl and phenyl phases.	Unique	L11
Pinnacle DB IBD	N	140	Proprietary	150	2.5 to 8.0	A polar group assists in deactivating surface silanols and contributes to unique separation selectivities for acids, bases, zwitterions, and other polar compounds.	One of a group of intrinsically base-deactivated (IBD) phases, with a polar group within, or intrinsic to, the alkyl bonded phase. Provides unique selectivity and high level of base deactivation while reducing or eliminating the need for mobile phase additives.	Unique	L68

LC Columns Physical Characteristics Chart (cont.)

HPLC Columns

Restek Column	End Cap?	Pore Size (Å)	Carbon Load (%)	Surface Area (m ² /g)	pH Range	Applications	Chromatographic Properties	Similar Phases	USP Code
Pinnacle DB PFP Propyl	Y	140	6	150	2.5 to 8.0	Exhibits excellent peak shapes for a wide range of compounds, including nucleosides, nucleotides, and halogenated compounds.	Highly base-deactivated spherical silica manufactured by Restek. Unique pentafluorophenyl phase with a propyl spacer.	Discovery HS F5	L43
Pinnacle DB Cyano	Y	140	4	150	2.5 to 8.0	Suitable for a wide range of compounds, from acidic through slightly basic. Also useful for confirmation of analyses on a C18 or C8 column. Can be used in normal phase or reversed-phase mode of separation.	Highly base-deactivated spherical silica manufactured by Restek. Cyano bonding.	Spherisorb Cyano, Zorbax CN	L10
Pinnacle DB Silica	N/A	140	N/A	150	2.8 to 8.0	Normal phase mode of separation.	Highly base-deactivated spherical silica manufactured by Restek.	Zorbax Silica	L3
Pinnacle DB PAH	N	140	Proprietary	150	2.5 to 8.0	Ideal for polycyclic aromatic hydrocarbons.	Specifically designed to resolve complex mixtures of polycyclic aromatic hydrocarbons.	Unique	—
Roc C18	Y	100	20	300	2.5 to 8.0	General-purpose HPLC column for a variety of compounds from acidic to slightly basic. Ideal for high-volume workflows using USP or other compendial type methods.	A very retentive, high-purity ODS phase that exhibits excellent peak shape for a wide range of compounds.	Hypersil Gold C18, Luna C18, Reliant C18, Symmetry C18, Zorbax Eclipse C18, Zorbax Eclipse XDB C18	L1
Roc C8	Y	100	12	300	2.5 to 8.0	General-purpose HPLC column for a variety of compounds from acidic to slightly basic. Ideal for high-volume workflows using USP or other compendial-type methods.	The shorter alkyl chain results in less hydrophobic retention and improved basic peak shape over a traditional C18.	Eclipse Plus C8, Hypersil Gold C8, Luna C8, Symmetry C8, Zorbax Eclipse XDB C8	L7
Roc Phenyl-Hexyl	Y	100	15	300	2.0 to 8.0	General-purpose HPLC column ideal for high-volume workflows using USP or other compendial-type methods. Recommended for aromatic analytes and complex samples.	A phenyl ring attached to a 6-carbon chain provides alternate selectivity to straight-chain hydrocarbon phases. Analyte interaction profile includes both dispersion and aromatic polarizability.	Eclipse Plus Phenyl-Hexyl, Hypersil Gold Phenyl, Luna Phenyl-Hexyl, Zorbax Eclipse XDB-Phenyl	L11
Roc Cyano	Y	100	8	300	2.5 to 8.0	Recommended for assays where alternate selectivity or confirmation to a C8 or C18 is desired. Also an excellent choice for protonated bases. Ideal for high-volume workflows using USP or other compendial-type methods.	Cyanopropyl silane that can be used in normal phase, reversed-phase, or HILIC modes.	Hypersil Cyano, Luna CN, XSelect CN, Zorbax Eclipse XDB-CN	L10
Roc Silica	N/A	100	N/A	300	2.5 to 8.0	Small nonpolar compounds in normal phase mode, polar compounds like water-soluble vitamins, steroids, and organic acids in HILIC mode.	Base-deactivated for normal phase or HILIC separations.	Hypersil Gold Silica, Luna Silica, Pursuit XRS-Si	L3
Raptor Biphenyl	Y	90	7 (2.7 μm) 5 (5 μm)	2.7 μm: 130, 5 μm: 100	2.0 to 8.0	Ideal for bioanalytical testing applications like drug and metabolite analyses. Heightened selectivity and retention for compounds that are hard to resolve or elute early on C18 and other phenyl chemistries.	Increased retention for dipolar, unsaturated, or conjugated solutes. Enhanced selectivity when used with methanolic mobile phase. Ideal for increasing sensitivity and selectivity in LC-MS analyses.	Accucore Biphenyl (2.6 μm), Ascensis Express Biphenyl, Halo Biphenyl (2.7 μm), Kinetex Biphenyl	L11
Raptor ARC-18	N	90	7 (2.7 μm) 5 (5 μm)	2.7 μm: 130, 5 μm: 100	1.0 to 8.0	Ideal for high-throughput LC-MS/MS applications with minimal sample preparation. Well-balanced retention profile for better detection and integration of large, multiclass analyte lists.	Well-balanced retention profile. Sterically protected and acid-resistant to withstand harsh, low-pH mobile phases. Ideal for use with sensitive detectors like mass spec.	Accucore XL C18, Ascensis Express Peptide ES-C18, Kinetex XB-C18, Poroshell 120 SB-C18	L1
Raptor C18	Y	90	7 (2.7 μm) 5 (5 μm)	2.7 μm: 130, 5 μm: 100	2.0 to 8.0	A traditional end-capped C18 ideal for general-purpose use in reversed-phase chromatography. pH range (2–8) provides excellent data quality for many applications, matrices, and compounds.	Compatible with moderately acidic to neutral mobile phases (pH 2–8). Excellent data quality in food, environmental, bioanalytical, and other applications.	Accucore C18, Accucore RP-MS, ACE UltraCore Super C18, Ascensis Express C18, Cortecs C18, Halo 2.7 C18, Kinetex C18, Nucleoshell RP 18, Poroshell EC-C18, Sunshell C18	L1
Raptor FluoroPhenyl	N	90	4 (2.7 μm) 3 (5 μm)	2.7 μm: 130, 5 μm: 100	2.0 to 8.0	HILIC applications and compounds like vitamin D epimers not well resolved on traditional C18 phases. Ideal for charged bases such as taxane drugs and other amine-containing compounds.	Electron-withdrawing fluorine atoms provide increased retention for charged bases. Reliable and efficient with acidic mobile phases for increasing selectivity and sensitivity in LCMS/MS analyses.	Accucore PFP, Ascensis Express F5, Halo 2.7 PFP, Kinetex PFP, Nucleoshell PFP, Poroshell PFP	L43
Raptor HILIC-Si	N/A	90	N/A	130	2.0 to 8.0	Ideal for small polar compounds, especially nitrogen-containing, which are protonated under high organic conditions. Recommended for the analysis of paraquat and diquat.	Retention of small polar molecules without ion-pairing reagents.	Accucore HILIC, Ascensis Express HILIC, Cortecs HILIC, Halo HILIC, Kinetex HILIC, Poroshell 120 HILIC	L3

LC Columns Physical Characteristics Chart (cont.)

HPLC Columns (cont.)

Restek Column	End Cap?	Pore Size (Å)	Carbon Load (%)	Surface Area (m ² /g)	pH Range	Applications	Chromatographic Properties	Similar Phases	USP Code
Ultra C1	N/A	100	5	300	2.5 to 8.0	Alternative selectivity to Ultra C18 or C8 columns, especially for polar analytes. Shortest chain alkyl phase available for reversed-phase separations.	Exceptionally stable C1 packing resists hydrolysis, even under acidic mobile phase conditions. Least retentive reversed-phase hydrocarbon packing.	Spherisorb C1	L13
Ultra C4	Y	100	9	300	2.5 to 8.0	Ideal for peptides and small proteins.	Exceptionally stable C4 packing, with high bonding coverage and silanol base deactivation. Exhibits shorter retention than C18 or C8 phases.	Delta-Pak C4, Supelcosil Butyl (C4)	L26
Ultra C8	Y	100	12	300	2.5 to 8.0	Selectivity and peak shape similar to Ultra C18, but less hydrophobic retention.	Very retentive, high-purity, base-deactivated reversed-phase packing that exhibits excellent peak shape for a wide range of compounds.	Eclipse Plus C8, Hypersil Gold C8, Luna C8, Symmetry C8, Zorbax Eclipse XDB C8	L7
Ultra C18	Y	100	20	300	2.5 to 8.0	Ideal for anilines, barbiturates, carbonyls, fat-soluble vitamins, fatty acids, glycerides, phthalates, PTH amino acids, steroids, other acids.	A very retentive, high-purity phase that exhibits excellent peak shape for a wide range of compounds. Recommended as a general-purpose reversed-phase column.	Develosil C18, Discovery C18, Eclipse Plus C-18, Hypersil Gold C18, Luna C18, Symmetry C18, Kromasil C18, LiChrospher RP-18, Luna C18, Symmetry C18, Zorbax Eclipse XDB-CB	L1
Ultra Aqueous C18	N	100	15	300	2.5 to 8.0	Ideal for analyses that require >90% water in the mobile phase. Excellent for highly water-soluble or poorly organic-soluble compounds. Excellent for water-soluble vitamins and organic acids.	Highly retentive and selective for reversed-phase separations of polar analytes. Highly base deactivated. Compatible with highly aqueous (up to 100%) mobile phases.	AQUA C18, Aquasil C18, Hypersil Gold AQ, YMC ODS-AQ	L1
Ultra Biphenyl	Y	100	15	300	2.5 to 8.0	An excellent choice for the analysis of steroids, tetracyclines, drug metabolites, and other compounds that contain some degree of unsaturation.	A unique reversed-phase material that exhibits both increased retention and selectivity for aromatic and/or unsaturated compounds, compared to conventional alkyl and phenyl phases.	Unique	L11
Ultra Aromax	Y	100	17	300	2.5 to 8.0	A very suitable choice for analysis of steroids, tetracyclines, drug metabolites, and other compounds that contain some degree of unsaturation.	A unique reversed-phase material that exhibits superior retention and selectivity for aromatic and/or unsaturated compounds, compared to conventional alkyl and phenyl phases. This column is a great alternative to our Biphenyl phase when increased retention is required.	Unique	L11
Ultra IBD	N	100	12	300	2.5 to 8.0	A polar group assists in deactivating surface silanols and contributes to unique separation selectivities for acids, bases, zwitterions, and other polar compounds.	One of a group of intrinsically base-deactivated (IBD) phases, with a polar group within, or intrinsic to, the alkyl bonded phase. Provides unique selectivity and high level of base deactivation while reducing or eliminating the need for mobile phase additives.	Discovery ABZ & ABZ+, Prism, SymmetryShield	L68
Ultra PFP Propyl	Y	100	11	300	2.5 to 8.0	Highly retentive for basic analytes. An excellent phase for separating nucleosides, nucleotides, purines, pyrimidines, and halogenated compounds.	A pentafluorophenyl phase with a propyl spacer.	Discovery HS F5, Luna PFP(2), Pursuit PFP	L43
Ultra Cyano	Y	100	8	300	2.5 to 8.0	Excellent for basic pharmaceuticals, steroids (normal or reversed-phase conditions), or other basic compounds.	High-purity cyano phase with reduced silanol activity. Often a better choice than C18 for basic pharmaceuticals. Cyano is the most stable bonded phase for normal phase mode.	Platinum CN, Develosil Cyano, Luna CN, Hypersil Gold CN, Zorbax Eclipse XDB-CN	L10
Ultra Amino	N	100	2	300	2.5 to 8.0	Superior general-purpose amino phase. Ideal for carbohydrates.	Recommended for normal phase analyses of mono- and disaccharides and other similar compounds. Can also serve as a weak anion exchanger, with aqueous buffers.	Platinum Amino, Develosil NH2	L8
Ultra Silica	N/A	100	N/A	300	2.5 to 8.0	Ideal for normal phase applications.	High purity, high surface area.	—	L3

LC Columns Physical Characteristics Chart (cont.)

Specialty Columns

Restek Column	End Cap?	Pore Size (Å)	Carbon Load (%)	Surface Area (m ² /g)	pH Range	Applications	Chromatographic Properties	Similar Phases	USP Code
Raptor EtG/EtS	—	90	Proprietary	130	2.0 to 8.0	Application-specific column for the analysis of ethanol metabolites ethyl glucuronide (EtG) and ethyl sulfate (EtS) in urine.	Reproducible retention of EtG and EtS resolved from matrix interferences.	Unique	—
Allure Silica	N/A	60	N/A	450	2.5 to 8.0	Highly retentive phase for normal phase separation. Recommended for MOSH/MOAH analysis.	High purity, highly retentive phase for normal phase separation of polar analytes. Very high surface area.	LiChrospher Si-60 (irregularly shaped particle), Maxsil Si (irregularly shaped particle)	L3
Allure AK	Y	60	Proprietary	450	2.5 to 8.0	Ideal for the analysis of aldehydes and ketones as DNPH derivatives.	Highly retentive, highly selective phase, developed specifically for the analysis of aldehydes and ketones as DNPH derivatives.	Unique	—
Allure Organic Acids	N	60	Proprietary	450	2.5 to 8.0	Excellent resolution of challenging organic acids.	Single 30 cm column performs equally to two C18 columns in series. (AOAC Method 986.13)	Unique	—
Pinnacle II PAH	N	110	Proprietary	180	2.5 to 8.0	Maximum resolution of polycyclic aromatic hydrocarbons.	Proprietary stationary phase; resolves 16 PAHs in US EPA Method 610. Silica manufactured by Restek.	Unique	—
Ultra Carbamate	—	100	Proprietary	300	2.5 to 8.0	Rapid analysis of carbamates.	Proprietary stationary phase can process up to twice as many samples per hour, compared to a conventional C18 phase.	Unique	—
Ultra Quat	—	100	Proprietary	300	2.5 to 8.0	Proprietary phase for the analysis of paraquat and diquat and other quaternary amines.	High-purity silica.	Unique	—

Large Molecule Columns

Restek Column	End Cap?	Pore Size (Å)	Carbon Load (%)	Surface Area (m ² /g)	pH Range	Applications	Chromatographic Properties	Similar Phases	USP Code
Viva C4	Y	300	3.5	100	2.5 to 8.0	Proteins and other higher molecular weight compounds. Less retentive than C18 and C8 phases.	Silica manufactured by Restek with a narrow distribution around the 300Å mean pore size for more surface interaction and analyte retention.	208 TP C4, BioBasic 4, Jupiter 300 C4, Symmetry 300 C4, Synchronapak C4	L26
Viva C8	Y	300	5	100	2.5 to 8.0	Proteins and other higher molecular weight compounds. Less retentive than C18 phase.	Silica manufactured by Restek with a narrow distribution around the 300Å mean pore size for more surface interaction and analyte retention.	208 TP C8, BioBasic 8, Synchronapak C8, Zorbax 300 OSB C8	L7
Viva C18	Y	300	9	100	2.5 to 8.0	Proteins and other higher molecular weight compounds.	Silica manufactured by Restek with a narrow distribution around the 300Å mean pore size for more surface interaction and analyte retention.	208 TP C18, BioBasic 18, Jupiter 300 C18, Symmetry 300 C18, Synchronapak C18, Zorbax 300 OSB C18	L1
Viva Biphenyl	Y	300	7	100	2.5 to 8.0	Exhibits excellent peak shape for a wide range of compounds; ideal for large molecule and biomolecule assays.	Silica manufactured by Restek with a narrow distribution around the 300Å mean pore size for more surface interaction and analyte retention.	Unique	L11
Viva PFP Propyl	Y	300	5	100	2.5 to 8.0	Exhibits excellent peak shape for a wide range of compounds, including nucleosides, nucleotides, and halogenated compounds.	Silica manufactured by Restek with a narrow distribution around the 300Å mean pore size for more surface interaction and analyte retention.	Unique	L43
Viva Silica	N/A	300	N/A	100	2.5 to 8.0	Normal phase applications for highly retained high molecular weight compounds.	Silica manufactured by Restek with a narrow distribution around the 300Å mean pore size for more surface interaction and analyte retention.	Unique	L3



Find us at
www.restek.com/lc

RESTEK
Pure Chromatography

Questions? Contact us or your local Restek representative (www.restek.com/contact-us).

Restek patents and trademarks are the property of Restek Corporation. (See www.restek.com/Patents-Trademarks for full list.) Other trademarks in Restek literature or on its website are the property of their respective owners. Restek registered trademarks are registered in the U.S. and may also be registered in other countries. To unsubscribe from future Restek communications or to update your preferences, visit www.restek.com/subscribe To update your status with an authorized Restek distributor or instrument channel partner, please contact them directly.

© 2019 Restek Corporation. All rights reserved. Printed in the U.S.A.

www.restek.com



Lit. Cat.# GNS52788A-UNV